

Supplement 1

Consumer Electronics Control (CEC)

CEC Table of Contents

CEC Page

CEC 1	INTRODUCTION	1
CEC 1.1	Normative references.....	1
CEC 1.2	Informative References.....	1
CEC 1.3	Document Revision History.....	1
CEC 2	DEFINITIONS.....	3
CEC 2.1	Conformance Levels	3
CEC 2.2	Glossary of Terms	3
CEC 2.3	Usages and Conventions.....	3
CEC 2.3.1	State Diagrams.....	3
CEC 2.3.2	Message Flow Diagrams.....	4
CEC 2.3.3	Notation	4
CEC 3	FEATURE OVERVIEW	5
CEC 3.1	End-User Features.....	5
CEC 3.2	Supporting Features	5
CEC 4	ELECTRICAL SPECIFICATION.....	6
CEC 5	SIGNALING AND BIT TIMINGS	8
CEC 5.1	CEC Line Usage.....	8
CEC 5.2	Bit Timing	8
CEC 5.2.1	Start Bit Timing.....	8
CEC 5.2.2	Data Bit Timing.....	8
CEC 6	FRAME DESCRIPTION	11
CEC 6.1	Header/Data Block description	11
CEC 6.1.1	EOM (End of Message).....	11
CEC 6.1.2	ACK (Acknowledge)	12
CEC 6.1.3	Header Block Details.....	12
CEC 7	RELIABLE COMMUNICATION MECHANISMS	13
CEC 7.1	Frame Re-transmissions.....	13
CEC 7.2	Flow Control.....	13
CEC 7.3	Frame Validation.....	13
CEC 7.4	CEC Line Error Handling	13
CEC 8	PROTOCOL EXTENSIONS.....	14
CEC 9	CEC ARBITRATION	15

CEC 9.1 Signal Free Time 15

CEC 9.2 Message Time Constraints 15

CEC 10 DEVICE CONNECTIVITY AND ADDRESSING16

CEC 10.1 Physical Address Discovery 16

CEC 10.2 Logical Addressing 16

 CEC 10.2.1 Logical Address Allocation 17

 CEC 10.2.2 Behaviour with Earlier Versions 18

CEC 11 SWITCH REQUIREMENTS19

CEC 11.1 CEC Switch..... 19

CEC 12 HIGH LEVEL PROTOCOL.....20

CEC 12.1 Source Declaration..... 20

CEC 12.2 Protocol General Rules..... 20

CEC 12.3 Feature Abort 20

CEC 12.4 Abort 21

CEC 13 CEC FEATURES DESCRIPTION22

CEC 13.1 One Touch Play 22

 CEC 13.1.1 Messages 22

 CEC 13.1.2 Feature Description 22

 CEC 13.1.3 Behaviour with Earlier Versions 23

CEC 13.2 Routing Control 23

 CEC 13.2.1 Messages 23

 CEC 13.2.2 Feature Description 23

 CEC 13.2.3 Behaviour with Earlier Versions 25

CEC 13.3 System Standby 26

 CEC 13.3.1 Messages 26

 CEC 13.3.2 Feature Description 26

 CEC 13.3.3 Behaviour with Earlier Versions 27

CEC 13.4 One Touch Record 27

 CEC 13.4.1 Messages 27

 CEC 13.4.2 Feature Description 27

 CEC 13.4.3 Behaviour with Earlier Versions 29

CEC 13.5 Timer Programming 29

 CEC 13.5.1 Messages 29

 CEC 13.5.2 Feature Description 29

 CEC 13.5.3 Performing a Timed Recording using another device as source 31

 CEC 13.5.4 Behaviour with Earlier Versions 31

CEC 13.6 System Information 31

 CEC 13.6.1 Messages 31

 CEC 13.6.2 Feature Description 31

 CEC 13.6.3 Additional Information 32

CEC 13.6.4 Behaviour with Earlier Versions 33

CEC 13.7 Deck Control 33

CEC 13.7.1 Messages 33

CEC 13.7.2 Feature Description 33

CEC 13.7.3 Behaviour with Earlier Versions 34

CEC 13.8 Tuner Control 34

CEC 13.8.1 Messages 34

CEC 13.8.2 Feature Description 34

CEC 13.8.3 Behaviour with Earlier Versions 35

CEC 13.9 Vendor Specific Commands 35

CEC 13.9.1 Messages 35

CEC 13.9.2 Feature Description 35

CEC 13.9.3 Behaviour with Earlier Versions 36

CEC 13.10 OSD Display 37

CEC 13.10.1 Messages 37

CEC 13.10.2 Feature Description 37

CEC 13.10.3 Behaviour with Earlier Versions 37

CEC 13.11 Device OSD Name Transfer 37

CEC 13.11.1 Messages 37

CEC 13.11.2 Feature Description 37

CEC 13.11.3 Behaviour with Earlier Versions 38

CEC 13.12 Device Menu Control 38

CEC 13.12.1 Messages 38

CEC 13.12.2 Feature Description 38

CEC 13.12.3 Behaviour with Earlier Versions 38

CEC 13.13 Remote Control Pass Through 39

CEC 13.13.1 Messages 39

CEC 13.13.2 Feature Description 39

CEC 13.13.3 Deterministic UI Functions 39

CEC 13.13.4 Behaviour with Earlier Versions 41

CEC 13.14 Give Device Power Status 41

CEC 13.14.1 Messages 41

CEC 13.14.2 Feature Description 41

CEC 13.14.3 Behaviour with Earlier Versions 42

CEC 13.15 System Audio Control 42

CEC 13.15.1 Messages 42

CEC 13.15.2 Feature Description 42

CEC 13.15.3 Behaviour with Earlier Versions 45

CEC 13.16 Audio Rate Control 45

CEC 13.16.1 Messages 45

CEC 13.16.2 Feature Description 45

CEC 13.16.3 Behaviour with Earlier Versions 45

CEC 14 DEVICE STATES 46

CEC 14.1.1 Device States 46

CEC 14.1.2 State Changes 46

CEC 14.1.3 All Devices 46

CEC 14.1.4 TV.....46
CEC 14.1.5 Recording Device.....47
CEC 14.1.6 Playback Device47
CEC 14.1.7 Menu Providing Device48

CEC 15 MESSAGE DESCRIPTIONS.....49

CEC 16 MESSAGE DEPENDENCIES71

CEC 17 OPERAND DESCRIPTIONS.....79

CEC APPENDIX A NON-CEC SWITCH (INFORMATIVE)97

CEC Figures

CEC Page

CEC Figure 1 Example State Diagram 4

CEC Figure 2 Example Message Flow Diagram 4

CEC Figure 3 Start bit pulse format showing minimum and maximum tolerances 8

CEC Figure 4 Timing diagrams for both bit states..... 9

CEC Figure 5 Timing Diagram for Follower Asserted Bit (Logical 0)..... 10

CEC Figure 6 Block Structure 11

CEC Figure 7 Header Block..... 12

CEC Figure 8 Logical Address Allocation 18

CEC Figure 9 A typical scenario illustrating the One Touch Play feature 22

CEC Figure 10 Example message flow, when a CEC Switch is manually switched 25

CEC Figure 11 A typical scenario for the broadcast (system) Standby feature..... 26

CEC Figure 12 A typical scenario for the Standby feature to a specific device 26

CEC Figure 13 A typical scenario for the One Touch Record feature..... 28

CEC Figure 14 A typical scenario for setting a Timer Record Block..... 30

CEC Figure 15 Message exchange when getting the TV’s menu Language 32

CEC Figure 16 A typical scenario when a menu language setting within the TV is modified 32

CEC Figure 17 A typical scenario for the Deck Control feature 34

CEC Figure 18 A typical scenario for selecting a new Service 35

CEC Figure 19 The messages sent in the Vendor Specific Commands feature 36

CEC Figure 20 A typical scenario for to discover the power status of a target device 41

CEC Figure 21 A typical scenario for initiating the System Audio Control feature from a TV or STB... 42

CEC Figure 22 A typical scenario for initiating the System Audio Control feature from an amplifier.... 43

CEC Figure 23 Typical Operation of the volume control 44

CEC Tables

CEC Page

CEC Table 1 CEC Electrical Specifications during the fully powered-Off state	6
CEC Table 2 CEC Electrical Specifications except during the fully powered-Off state	7
CEC Table 3 Frame Description	11
CEC Table 4 Signal Free Time.....	15
CEC Table 5 Logical Addresses.....	17
CEC Table 6 Deterministic UI Functions.....	40
CEC Table 7 Message Descriptions for the One Touch Play Feature.....	50
CEC Table 8 Message Descriptions for the Routing Control Feature	51
CEC Table 9 Message Descriptions for the Standby Feature.....	53
CEC Table 10 Message Descriptions for the One Touch Record Feature	54
CEC Table 11 Message Descriptions for the Timer Programming Feature.....	55
CEC Table 12 Message Descriptions for the System Information Feature	57
CEC Table 13 Message Descriptions for the Deck Control Feature	59
CEC Table 14 Message Descriptions for the Tuner Control Feature	60
CEC Table 15 Message Descriptions for the Vendor Specific Commands Feature	61
CEC Table 16 Message Descriptions for the OSD Display Feature.....	63
CEC Table 17 Message Descriptions for the Device OSD Transfer Feature.....	64
CEC Table 18 Message Descriptions for the Device Menu Control Feature	65
CEC Table 19 Message Descriptions for the Remote Control Passthrough Feature.....	66
CEC Table 20 Message Descriptions for the Power Status Feature	66
CEC Table 21 Message Descriptions for General Protocol messages	67
CEC Table 22 Message Descriptions for the System Audio Control Feature	68
CEC Table 23 Message Descriptions for the Audio Rate Control Feature.....	70
CEC Table 24 Message dependencies when receiving a message	71
CEC Table 25 Message dependencies when sending a message	75
CEC Table 26 Operand Descriptions.....	79
CEC Table 27 User Control Codes	95
CEC Table 28 Broadcast System.....	96

CEC 1 Introduction

CEC is a protocol that provides high-level control functions between all of the various audiovisual products in a user's environment. This appendix describes the CEC protocol in the following order:

- An overview of the recommended features available in CEC.
- A Low Level Protocol Definition - Includes the electrical specification, signaling and bit timings and the frame description.
- A High Level Protocol Definition - Includes a detailed feature breakdown and individual message descriptions.

CEC 1.1 Normative references

[1n] ISO 639.2 Code for the representation of names of languages - Part 2: Alpha 3 code
<http://www.loc.gov/standards/iso639-2/langhome.html>

CEC 1.2 Informative References

[1i] CENELEC, EN 50049-1:1997/A1:1998, Domestic and similar electronic equipment interconnection requirements: Peritelevision connector

[2i] CENELEC, EN 50157, Domestic and similar electronic equipment interconnection requirements: AV.link
 EN 50157-1 : Part 1
 EN 50157-2-1 : Part 2-1
 EN 50157-2-2 : Part 2-2
 EN 50157-2-3 : Part 2-3

[3i] IEEE std. 1394-1995 HIGH PERFORMANCE SERIAL BUS section 8.3.2.5.1 – example use of Company_id.

CEC 1.3 Document Revision History

- 1.2 Clarification of CEC line Standby behaviour
 Clarification of test conditions in Table 2
 Addition of CEC line pull-up using a current source
 Addition of Give Power Status message
 Clarification of response to <Abort> message
- 1.2a Tolerance on internal pull-up resistance changed to $\pm 5\%$ in Table 2.
 Removal of test conditions from Table 2,
 Clarification of maximum message length.
 Re-ordering of some Features in the text and splitting of message description table.
 Update and clarification of mandatory and optional implementation status.
 Clarification of rules with more explanations for Routing Control.
 Additional examples and notes regarding the use of System Standby with recordings.
 System Info simplified to language selection. <Set Language> now becomes <Set Menu Language> with a simplified mechanism. Removal of <Set System Info Version Number>, <Give System Info> and <Set Country>.
 Removal of analogue tuning messages and addition of <Select Digital Service>.
 Removal of Preset Download and Timer Programme Features.
 Various editorial corrections throughout

- 1.3a Clarification of pull-up resistance (for integrated implementations) and negative overshoot on CEC line.
Clarification of when CEC Line Error Checking is applied.
Clarification of Signal Free Time values.
Re-naming of addresses STB to Tuner and DVD to Playback device.
Allocation of Tuner 4 and Playback Device 3 Logical Addresses from reserved set.
<Image View On> and <Text View On>: change to mandatory behavior with displayed OSD/Menu
<Set Stream Path>: changes to mandatory behavior.
<Routing Change>: changes to mandatory behavior and addition of timing recommendation.
Standby: clarification of behavior.
Extension of <Record On> to tuners and addition of Analogue and External sources.
Addition of new Error Codes for <Record Status>.
Addition of Timer Programming Feature (Analogue, digital and external).
Addition of Analogue Tuning <Select Analogue Service> to Tuner.
Addition of Major/Minor and 4-digit Virtual Channel Identification
Addition of <Get CEC Version> and <CEC Version>.
Change of some names for [Play Mode] and [Deck status] codes to better indicate responses.
Allow <Vendor Command> to be shared between manufacturers in specific circumstances.
Addition of <Vendor Command With ID> message, which may also be broadcast.
Inconsistent Feature naming now unified to "OSD Display".
Clarification and addition of recommendation for a timeout for the User Commands.
RC passthrough: Addition of Pause-Record, Data, Power (On, Off and toggle); clarification of <Root Menu>.
<Device Power Status> now made mandatory for an Initiator.
Addition of System Audio Control Feature.
Addition of Audio Rate Control Feature.
Updates to Message Dependencies and Operands tables as a result of above.
Correction to ASCII range.
Various editorial corrections throughout.

CEC 2 Definitions

CEC 2.1 Conformance Levels

Because CEC is optional, the conformance level in this appendix is only effective when the device supports CEC. For example, the word "shall" indicates a mandatory requirement for the CEC supporting devices. However, within the Features section (CEC 13) "shall" only indicates a requirement if the feature is implemented.

CEC 2.2 Glossary of Terms

Broadcast Message	This is a message, sent to logical address 15, which all devices are expected to receive.
Clear	Set to an empty/undefined state. When a physical address is cleared it takes the value F.F.F.F. When a logical address is cleared it takes the value 15.
Deck	The part of a Recording Device or Playback Device that provides playback functionality e.g. from a removable media.
Destination	The target device for a CEC message.
Follower	A device that has just received a CEC message and is required to respond to it.
Initiator	The device that is sending, or has just sent, a CEC message and, if appropriate, is waiting for a follower to respond.
Logical address	A unique address assigned to each device (see section CEC 10.2)
Menu Providing Device	A non-display device that may render a menu on TV.
Playback device	A device that has the ability to play media, e.g. a DVD Player.
Recording device	A device that has the ability to record a source such as an internal tuner or an external connection.
Source Device	A device that is currently providing an AV stream via HDMI.
Tuner Device	A device that contains a tuner, e.g. a STB or a Recording Device.
Timer Setting Device	A device that has the ability to set the record timer blocks of a Recording Device.
TV	A device with HDMI input that has the ability to display the input HDMI signal. Generally it has no HDMI output.

CEC 2.3 Usages and Conventions

CEC 2.3.1 State Diagrams

State diagrams describe behavior in terms of device states and events or actions. In these diagrams, the ovals represent device states and the arrows represent events and/or actions that move the device from one state to another state.

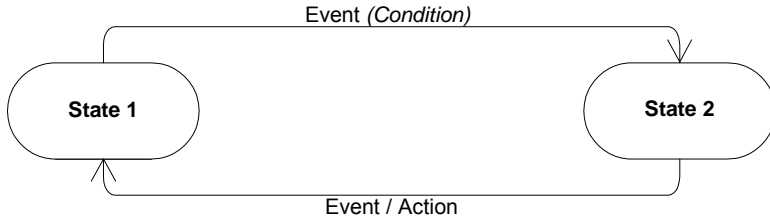

CEC Figure 1 Example State Diagram

CEC 2.3.2 Message Flow Diagrams

Message Flow Diagrams show sequences of messages that occur between 2 devices.

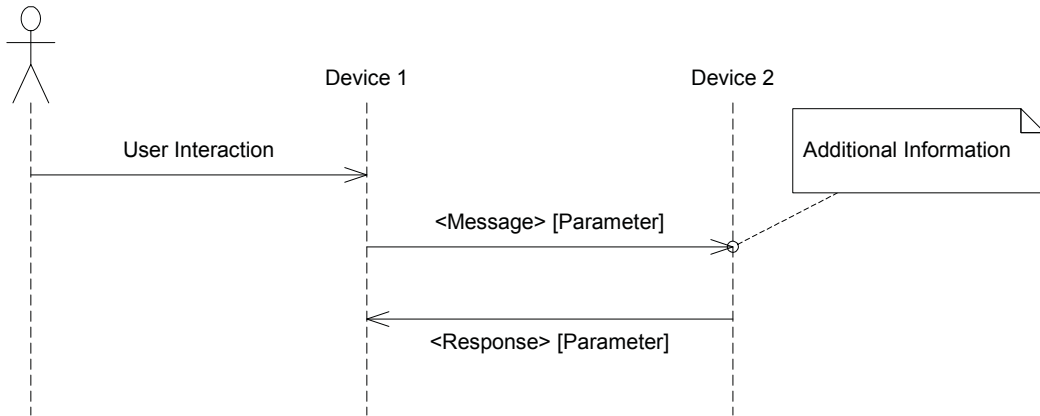

CEC Figure 2 Example Message Flow Diagram

CEC 2.3.3 Notation

Within the CEC specification there are a number of notations:

<xxx> xxx is an opcode for a message, which is defined in section CEC 15

[yyy] yyy is a data item, which is defined in section CEC 17.

“zzz” zzz is a constant and is a possible value for a data item in section CEC 17.

N{...} indicates the item within the braces is repeated N times, this is used mainly in section CEC 17.

CEC 3 Feature Overview

CEC provides a number of features designed to enhance the functionality and interoperability of devices within an HDMI system. This section gives an overview of these features.

CEC 3.1 End-User Features

One Touch Play - Allows a device to be played and become the active source with a single button press.

System Standby - Enables the user to switch all devices to standby with one button press.

One Touch Record - Offers a What You See Is What You Record (WYSIWYR) facility, meaning that whatever is shown on the TV screen is recorded on a selected Recording Device.

Timer Programming – Allows the user to program the timers in a Recording Device from an EPG running on a TV or STB.

Deck Control - Enables a device to control (e.g. play, fast forward etc.) and interrogate a Playback Device (a deck).

Tuner Control - Allows a device to control the tuner of another device.

Device Menu Control - Enables a device to control the menu of another device by passing through user interface commands.

Remote Control Pass Through - Enables remote control commands to be passed through to other devices within the system.

System Audio Control – Allows an Audio Amplifier / Receiver to be used with the TV. The volume can be controlled using any the remote controls of any suitably-equipped devices in the system.

CEC 3.2 Supporting Features

Device OSD Name Transfer - Enables devices to upload their preferred OSD name to the TV. The TV can then use this name in any menus associated with that device.

Device Power Status – Allows the current power status of a device to be discovered.

OSD Display - Enables a device to use the on-screen display of the TV to display text strings.

Routing Control - Allows the control of CEC Switches for streaming of a new source device.

System Information - Queries the system to determine device addresses and language.

Vendor Specific Commands - Allows a set of vendor-defined commands to be used between devices of that vendor.

Audio Rate Control – Allows an Amplifier to fractionally increase or decrease the playback rate of an audio source.

CEC 4 Electrical Specification

The electrical specifications define CEC such that a maximum of 10 devices can interoperate in the worst-case scenario. In practice, many more may be expected to operate together as the worst case is highly improbable.

A device that implements CEC protocols, as described in this CEC supplement, and has enabled its CEC functionality, shall:

- Conform to Table 1 when it is powered-Off (e.g. power removed); or,
- Conform to Table 2 in all other power states. In these states, the device shall keep monitoring the CEC line for any messages addressing that device, including any messages that bring the device out of Standby, see CEC 14.1.3.

During the powered-Off state (e.g. power removed), the CEC line is not monitored.

CEC Table 1 CEC Electrical Specifications during the fully powered-Off state

Description	Value	Notes
Leakage current in powered-Off state	1.8 μ A max	1

CEC Table 2 CEC Electrical Specifications except during the fully powered-Off state

Description	Value	Notes
Maximum Output Voltage Logic '0'	+0.6V	
Minimum Output Voltage Logic '0'	0V	3
Maximum Output Voltage Logic '1'	+3.63 V	
Minimum Output Voltage Logic '1'	2.5V	
High to Low Input Voltage Threshold Logic '0'	$V_{cecin('0')} \geq +0.8V$	
Low to High Input Voltage Threshold Logic '1'	$V_{cecin('1')} \leq +2.0V$	
Typical Input hysteresis	+0.4 V	2
Maximum rise time (10% to 90%)	250 μ s	
Maximum fall time (90% to 10%)	50 μ s	
Internal device pull-up:	27k ohms \pm 5% or equivalent (eg a current source); or 26k ohms \pm 10% when integrated.	

The device shall remain within specification under the full-range of load conditions.

Notes:

- 1 This effectively requires that the internal pull-up circuit shall be disconnected from the CEC line when the device is off. For example, this can be implemented by connecting an isolating diode between the CEC input pin and the internal pull-up circuit, such that diode is reverse-biased in the off state with an external device pulling-up the CEC line.
- 2 For information, input hysteresis is normally supplied by the microprocessor input circuit: in this circumstance, external hysteresis circuitry is not needed.
- 3 During transition from Logic '1' to Logic '0' a negative overshoot with maximum 300mV and up to 150 μ s duration is allowed.

CEC 5 Signaling and Bit Timings

All transactions on the CEC line consist of an initiator and one or more followers. The initiator is responsible for sending the message structure and the data. The follower is the recipient of any data and is responsible for setting any acknowledgement bits.

CEC 5.1 CEC Line Usage

A message is conveyed over the control signal line in a single frame; a frame is a self-contained unit consisting of a start bit followed by a number of data bits.

An initiator first has to test that the control signal line is free for use (described below). After that it generates a high to low transition on the CEC line, followed by a series of pulses comprising data bits whose starting point is defined by a high to low transition.

The initiator provides bit timing and bit leading edges. Only one initiator is allowed at any one time. A control signal line arbitration mechanism avoids conflict when more than one initiator begins transmitting at the same time.

CEC 5.2 Bit Timing

CEC 5.2.1 Start Bit Timing

The pulse format of the start bit is shown in CEC Figure 3. It is unique and identifies the start of a frame.

The start bit has to be validated by its low duration (a) and its total duration (b).

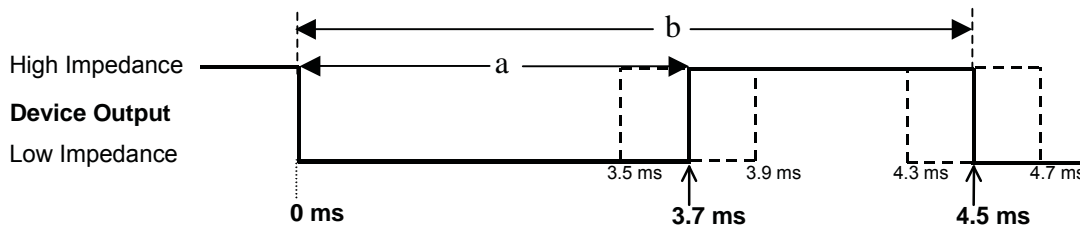

CEC Figure 3 Start bit pulse format showing minimum and maximum tolerances

CEC 5.2.2 Data Bit Timing

All remaining data bits in the frame, after the start bit, have consistent timing. There are, however, two types of bits; an initiator asserted bit and a follower asserted bit. All bits apart from the acknowledge bit are asserted by the initiator. CEC Figure 4 shows both logical 1 and logical 0 timing diagrams for an initiator asserted bit.

The high to low transition at the end of a data bit is the start of the next data bit and only occurs if there is a following data bit; after transmission of the final bit the CEC line remains high.

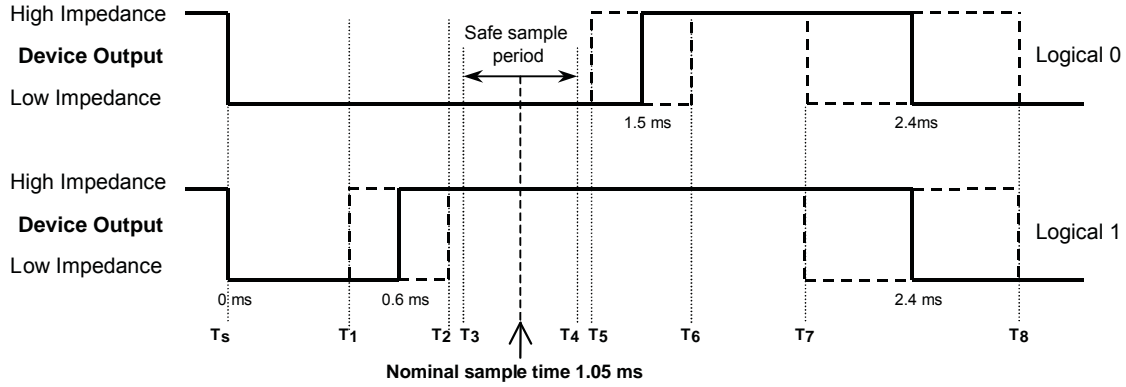

T_s	0 ms	The bit start event.
T₁	0.4 ms	The earliest time for a low - high transition when indicating a logical 1.
T₂	0.8 ms	The latest time for a low - high transition when indicating a logical 1.
T₃	0.85 ms	The earliest time it is safe to sample the signal line to determine its state.
T₄	1.25 ms	The latest time it is safe to sample the signal line to determine its state.
T₅	1.3 ms	The earliest time a device is permitted return to a high impedance state (logical 0).
T₆	1.7 ms	The latest time a device is permitted return to a high impedance state (logical 0).
T₇	2.05 ms	The earliest time for the start of a following bit.
	2.4ms	The nominal data bit period.
T₈	2.75 ms	The latest time for the start of a following bit.

CEC Figure 4 Timing diagrams for both bit states

CEC Figure 5 shows an example bit with both initiator and follower where the follower may assert the bit to a logical 0 to acknowledge a data block. The initiator outputs a logical 1, thus allowing the follower to change the CEC state by pulling the control line low for the duration of the safe sample period.

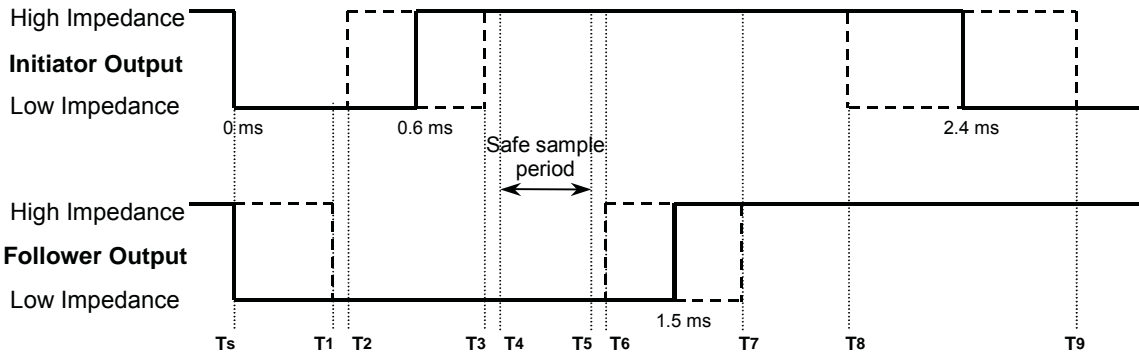

T_s	0 ms	The bit start event.
T₁	0.35 ms	The latest response time for a follower to go to the low impedance state.
T₂	0.4 ms	The earliest the initiator can return to high impedance when transmitting a logical 1.
T₃	0.8 ms	The latest the initiator can return to high impedance when transmitting a logical 1.
T₄	0.85 ms	The earliest time at which the bit state on the CEC line is valid for reading.
T₅	1.25 ms	The latest time at which the bit state on the CEC line is valid for reading.
T₆	1.3 ms	The earliest time the follower is permitted return to a high impedance state.
T₇	1.7 ms	The latest time the follower is permitted return to a high impedance state.
T₈	2.05 ms	The earliest time for the start of a following bit.
	2.4ms	The nominal data bit period.
T₉	2.75 ms	The latest time for the start of a following bit.

CEC Figure 5 Timing Diagram for Follower Asserted Bit (Logical 0)

CEC 6 Frame Description

The following table describes the complete CEC frame; the details of each block of the frame are given in the subsequent sections.

CEC Table 3 Frame Description

Name	Description	Value
Start	Special start 'bit'	N/A
Header Block	Source and destination addresses (see CEC Figure 7)	See CEC Table 5
Data Block 1 (opcode block)	Opcode (Optional)	See CEC Table 7 to Table 23
Data Block 2 (operand blocks)	Operand(s) specific to opcode (Optional, depending on opcode)	See CEC Table 26

The maximum message size (header block plus opcode block plus operand blocks) is 16 * 10 bits

CEC 6.1 Header/Data Block description

All Data Blocks and Header Blocks are ten bits long and have the same basic structure, as shown in CEC Figure 6.

Header/Data Block									
7	6	5	4	3	2	1	0	-	-
Information bits								EOM	ACK

CEC Figure 6 Block Structure

The information bits are data, opcodes or addresses, dependent on context. The control bits, EOM and ACK, are always present and always have the same usage.

CEC 6.1.1 EOM (End of Message)

The EOM bit is used to indicate if this is the final block in the message.

A '0' bit specifies that one or more data blocks follow.

A '1' bit specifies that the message is complete.

In the event that a message contains additional data blocks after an EOM is indicated, the follower shall ignore the additional blocks.

CEC 6.1.2 ACK (Acknowledge)

The ACK bit is used by follower(s) to acknowledge the data or header block. It is always set to 1 by the initiator. It operates in one of two modes:

For messages addressed to a single device:

- A follower that reads its own address in the destination address field shall acknowledge with a '0' ACK bit.
- All other devices shall not assert the ACK bit to logical '0'.
- A '0' read by the initiator therefore indicates a successful transmission of the data or header block.

For broadcast messages the sense of the ACK bit is inverted to allow for a single device to reject a message:

- All followers that do not want to reject the message shall not assert the ACK bit to logical '0'.
- A '1' read by the initiator therefore indicates that no device has rejected the data or header block – the message transmission can therefore continue if required.
- A follower that wants to reject a broadcast message shall generate a "0" ACK bit.
- A '0' read by the initiator therefore indicates that one or more devices have rejected the message.

CEC 6.1.3 Header Block Details

The header block consists of the source logical address field, the destination logical address field, the end of message bit (EOM) and the acknowledge bit (ACK) as shown in CEC Figure 7. The addresses for the devices are specified in CEC Table 5.

Header Block									
3	2	1	0	3	2	1	0	-	-
Initiator				Destination				EOM	ACK

CEC Figure 7 Header Block

The initiator logical address field is used to identify the initiator of the current frame. The logical address of the initiator is written in this field (see CEC 10.2). The field consists of bits one to four of the header block, most significant bit first.

The destination logical address field is used to identify the destination of the current frame. The logical address of the destination is written in this field (see CEC 10.2). A special address (0b1111) is used for broadcast messages. The field consists of bits five to eight of the header block, most significant bit first.

A message with the EOM bit set in the Header Block can be used to 'ping' other devices, to ascertain if they are powered on. This is the <Polling Message> and the Initiator and Destination addresses will be different. It is also used in 10.2.1 for allocating Logical Addresses: in this case the Initiator and Destination addresses are the same.

CEC 7 Reliable Communication Mechanisms

There are three mechanisms to provide a reliable communications medium for the transfer of frames:

- Frame re-transmissions increase the chance of a successful message transfer.
- Flow control ensures that communication only progresses as fast as the slowest follower.
- Frame validation.

Given these mechanisms and the active ACK method, a message transmitted and acknowledged should be assumed correctly received. A message that does not result in a <Feature Abort> can be assumed to have been acted upon. It is suggested that the receiving device can assume this after 1 second. Generally however, the <Feature Abort> will be received within around 100ms.

CEC 7.1 Frame Re-transmissions

A valid frame is considered lost and therefore may be re-transmitted under the following conditions:

- If a frame is not acknowledged in a directly addressed message.
- If a frame is negatively acknowledged in a broadcast message.
- If the initiator detects low impedance on the CEC line when it is transmitting high impedance and is not expecting a follower asserted bit.

Re-transmission can be attempted up to 5 times for a single message and shall be attempted at least once. The re-try shall be after a signal free time as described in CEC Table 4.

CEC 7.2 Flow Control

To provide flow control, a receiving device may negatively acknowledge any data or header block it is at present unable to process. A negative acknowledge will cause re-transmission by the initiator.

CEC 7.3 Frame Validation

A follower shall ignore a frame if the number of operands is less than the number specified for that opcode.

CEC 7.4 CEC Line Error Handling

It is the responsibility of all devices acting as followers to detect the existence of spurious pulses on the control signal line and notify all other devices (primarily the initiator) that a potential error has occurred.

An error is defined as a period between falling edges that is less than a minimum data bit period (i.e. too short to be a valid bit). Note that the start bit has different timing from normal data bits and is used to identify a valid CEC message. CEC Line Error checking shall start only after receiving a valid start bit.

Errors are notified by the follower generating a low bit period on the control signal line of 1.4-1.6 times the nominal data bit period. After such an error notification the original initiator should stop sending its current frame and re-try later.

CEC 8 Protocol Extensions

In order to allow for extensions to the protocol in future releases of the specification, the current opcodes and parameters can be extended by adding further parameters onto them. If an older CEC node receives a message with more operands than expected, it should ACK the additional operands and simply ignore them, thus allowing extensions to already existing commands.

For entirely new commands, new opcodes can be allocated.

For entirely new device types, new addresses may be allocated.

CEC 9 CEC Arbitration

Arbitration for the CEC line ensures collisions are spotted and a reliable message layer can be achieved.

All devices that want to transmit a frame onto the CEC line have to ensure that it has been inactive for the signal free time, see CEC Table 4.

A device that has lost arbitration shall stop transmitting and become a follower. The device shall then wait for the CEC line to be inactive for the signal free time period as specified in CEC Table 4, before attempting to send another message.

CEC line arbitration commences with the leading edge of the start bit and continues until the end of the initiator address bits within the header block. During this period the initiator shall monitor the CEC line and if whilst in high impedance state it detects low impedance then it shall assume that it has lost the arbitration to a second initiator.

It should be noted that this process gives priority to the logical address with the most leading zeros and, ultimately, the TV.

CEC 9.1 Signal Free Time

Before attempting to transmit or re-transmit a frame, a device shall ensure that the CEC line has been inactive for a number of bit periods. This signal free time is defined as the time since the start of the final bit of the previous frame.

The length of the required signal free time depends on the current status of the control signal line and the initiating device. The different signal free times required are summarized in the following table:

CEC Table 4 Signal Free Time

Precondition	Signal Free Time (nominal data bit periods)
Present initiator wants to send another frame immediately after its previous frame	≥ 7
New initiator wants to send a frame	≥ 5
Previous attempt to send frame unsuccessful	≥ 3

This means that there is an opportunity for other devices to gain access to the CEC line during the periods mentioned above to send their own messages after the current device has finished sending its current message.

CEC 9.2 Message Time Constraints

There are certain time constraints for messages that should be obeyed at application level. These are a desired maximum response time of 200ms and a required maximum response time of 1 second.

CEC 10 Device Connectivity and Addressing

CEC is a protocol based on a bus system and therefore cannot alone ascertain the physical connectivity of the network. The mechanism defined in section 8.7 uses DDC to allocate physical addresses to devices in the network.

All CEC devices therefore have both a physical and logical address, whereas non-CEC devices only have a physical address.

CEC 10.1 Physical Address Discovery

The algorithm defined in 8.7.3 is used to allocate the physical address of each device.

Whenever a new physical address (other than F.F.F) is discovered, a CEC device shall:

- allocate the logical address (see CEC 10.2.1)
- report the association between its logical and physical addresses by broadcasting <Report Physical Address>.

This process allows any node to create a map of physical connections to logical addresses.

CEC 10.2 Logical Addressing

Each device appearing on the control signal line has a logical address which is allocated to only one device in the system. This address defines a device type as well as being a unique identifier. These are specified in CEC Table 5.

If a physical device contains the functions of more than one logical device then it should take the logical addresses for each of those logical devices. For example, a if a DVD recorder has a tuner, it may take one of the addresses 3, 6, 7 or 10 (Tuner) in addition to one of 1,2 or 9 (Recording Device).

It is allowed for a device to declare the functionality of another device by using a different logical address. For example a recordable DVD device may take the address 4 or 8 to expose only the functionality of a standard DVD Playback Device. In this case, the recording functionality will not be available or controllable via CEC.

A Recording Device with addresses 1,2 or 9 (Recording Device) shall not also take a Playback Device address as the playback functionality is also included in the recorder functionality.

If a device has multiple instances of a particular functionality, it should advertise only one instance. For instance, if a device has multiple tuners, it should only expose one for control via CEC. In this case, it is up to the device itself to manage multiple tuners.

A device shall advertise a function with a Logical Address, such as a Tuner, only if it supports at least the mandatory messages for that function.

CEC Table 5 Logical Addresses

Address	Device
0	TV
1	Recording Device 1
2	Recording Device 2
3	Tuner 1
4	Playback Device 1
5	Audio System
6	Tuner 2
7	Tuner 3
8	Playback Device 2
9	Recording Device 3
10	Tuner 4
11	Playback Device 3
12	Reserved
13	Reserved
14	Free Use
15	Unregistered (as initiator address) Broadcast (as destination address)

CEC 10.2.1 Logical Address Allocation

Note that a logical address should only be allocated when a device has a valid physical address (i.e. not F.F.F.F), at all other times a device should take the 'Unregistered' logical address (15).

Only the device at physical address 0.0.0.0 may take logical address TV (0). A TV at any other physical address shall take the 'Free Use' (14) address. If address 14 is already allocated it shall take the 'Unregistered' address (15).

Reserved addresses shall not be used at present and are reserved for future extensions to this specification.

Where more than one possible logical address is available for the given device type (e.g. Tuner 1, Tuner 2, etc.), an address allocation procedure shall be carried out by a newly connected device. The device takes the first allocated address for that device type and sends a <Polling Message> to the same address (e.g. Tuner 1 → Tuner 1). If the <Polling Message> is not acknowledged, then the device stops the procedure and retains that address.

If the first address is acknowledged, then the device takes the next address for that device type and repeats the process (e.g. Tuner 2 → Tuner 2). Again, if the message is not acknowledged, the device keeps that address.

This procedure continues until all possible 'type specific' addresses have been checked; if no 'type specific' addresses are available the device should take the unregistered address (15). Note that several physical devices might be sharing this address.

A device may lose its logical address when it is disconnected or switched off. However, it may remember its previous logical address, so that the next time it is reconnected or switched on, it can begin the polling process at its previous logical address and try each other allowable logical address in sequence before taking the unregistered address. For example if an STB that was previously allocated address Tuner 2 is reconnected, it would poll Tuner 2, Tuner 3, Tuner 4 and Tuner 1 before taking the unregistered address.

If a device loses its physical address at any time (e.g. it is unplugged) then its logical address should be set to unregistered (15).

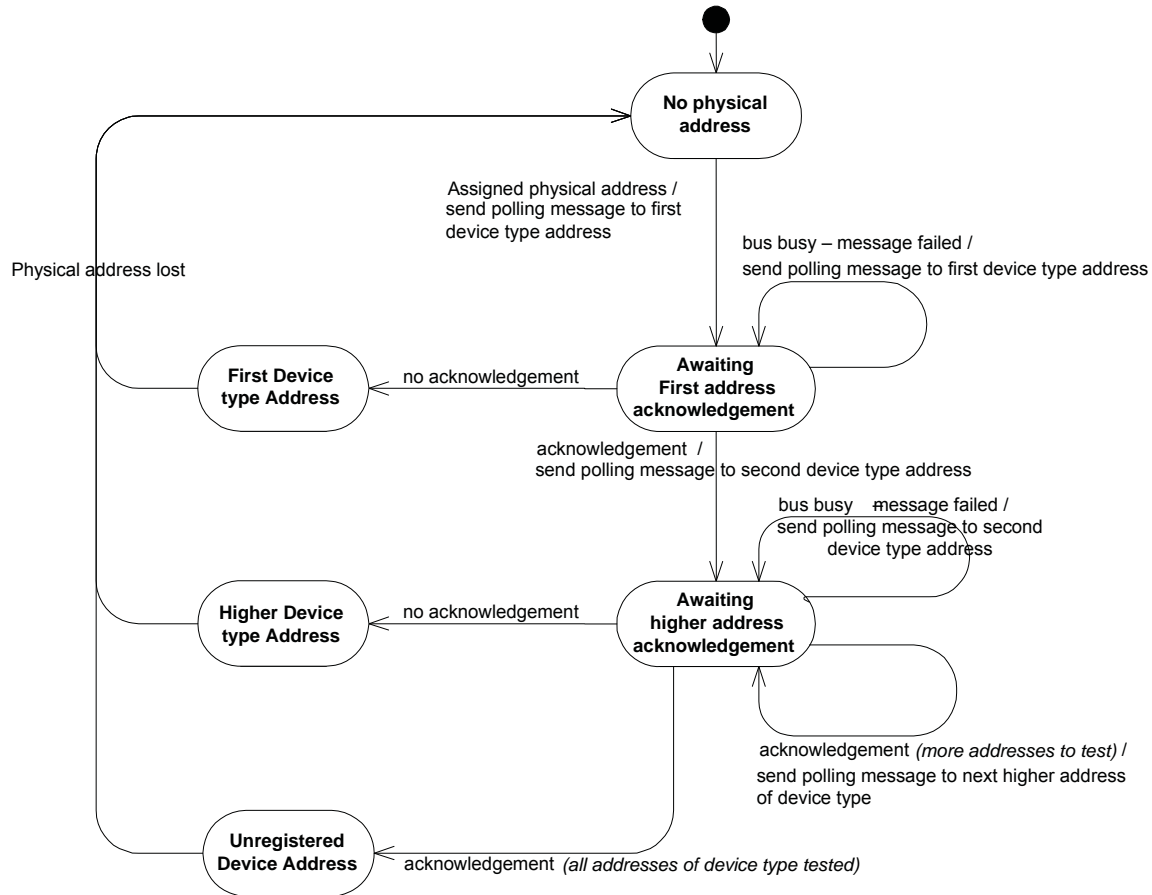

CEC Figure 8 Logical Address Allocation

CEC 10.2.2 Behaviour with Earlier Versions

CEC Version 1.3a adds new Logical Addresses of Tuner 4 and Playback Device 3: these will not be recognized by devices conforming to CEC specifications before CEC version 1.3a.

CEC 11 Switch Requirements

One of the major uses of the physical address identification is to allow a Switch to be controlled in order to enable a specific device to stream to the TV.

All Switches consist of a single switched TMDS connection, and a fully wired CEC connection to each source device. A CEC Switch can interpret and send CEC messages and can be switched by CEC messages.

The use of non-CEC Switches is deprecated. These do not interpret nor send CEC messages and cannot be switched by CEC messages. Non-CEC Switches stop the correct operation of many CEC Features including mandatory Features such as One Touch Play. They also prevent other CEC-compliant devices from operating correctly. Further information on non-CEC Switches can be found in CEC Appendix A.

CEC 11.1 CEC Switch

A CEC Switch allocates a unique `child_address` for every connection below the Switch, ie it allocates the address for devices connected to the inputs of the Switch. This means that any device connected to the Switch will always have a valid physical address (assuming the Switch itself has a valid physical address). Therefore, any device below the Switch may take a logical address and can react to CEC messages in a normal way. The Switch is effectively transparent and will enable all standard CEC communications in its connected source devices.

A CEC Switch can be part of another device, such as a TV or audio amplifier with two or more HDMI inputs. Such a device shall provide its advertised functionality (eg TV or Audio System) in addition to its CEC Switch functionality. In these cases, the Switch takes the relevant address of its advertised functionality, ie 0 (TV) or 5 (Audio System). The power control for the Switch functionality should be separate from the power control for the other functionality so that the Switch can be active even when the main functionality is in Standby – see CEC 13.2.2 for more details.

Note that if a device has only one HDMI input and a number of non-HDMI inputs, then that should not be considered to be a CEC Switch.

A device that is a “pure” CEC Switch and has no other functionality uses the Unregistered address (15) for communications.

For CEC Switches, there is a requirement to react on <Active Source> and <Set Stream Path> messages. Both of these messages require the Switch to change to the source device according to the physical AV stream path indicated by the CEC message. These mechanisms allow a source device to configure the Switches between itself and the TV to ensure that its output is displayed, or for the TV to specifically receive the output from a given device.

It is possible that a user may change a CEC Switch manually. In this instance a CEC Switch shall send a <Routing Change> message to inform other devices about the change –see section CEC 13.2.2.

CEC 12 High Level Protocol

As described in the previous sections, messages consist of an opcode and a number of parameters. This is the high level protocol.

This protocol can be described best by detailing the messages and the data types used for the parameters. These are detailed in CEC Table 7 to Table 23.

Although these tables explain the majority of the high level protocol, there are some special situations that require further explanation. These are given in the following sections.

CEC 12.1 Source Declaration

For a device to act as a Source Device, it shall issue an <Active Source> message to declare its intention. Thus any presently active source shall act appropriately.

CEC 12.2 Protocol General Rules

A message that is defined as being valid only when directly addressed shall be ignored if received as a broadcast message.

A message that is defined as being valid only when broadcast shall be ignored if received as a directly addressed message.

All numbers greater than one byte are transmitted as bytes in big endian format.

All bit sequences are sent most significant bit first.

A follower shall respond to a message coming from any valid logical address from 0 to 14 unless otherwise stated.

A follower shall ignore a message coming from address 15 (unregistered), unless:

- that message invokes a broadcast response (e.g. <Get Menu Language>), or,
- the message has been sent by a CEC Switch (a <Routing Change> or <Routing Information> message), or,
- the message is <standby>.

CEC 12.3 Feature Abort

All devices shall support the message <Feature Abort>. It is used to allow devices to indicate if they do not support an opcode that has been sent to them, if it is unable to deal with the message at present, or if there was something wrong with the transmitted frame at the high-level protocol layer.

Feature abort has two parameters, the opcode and a reason for its rejection of the frame.

The reaction to a faulty message by the follower depends on if the message was directed or broadcast:

For a broadcast message:

- A follower that receives a broadcast message which it does not support, ignores the received message, and does not send a <Feature Abort>.

For a directly addressed message:

- <Feature abort> is used as a response to any failure.

If an initiator wants to attempt retransmission after receiving a <Feature Abort> it is suggested that it waits for 200ms. This will allow time for the follower to recover from the state that caused the initial <Feature Abort> message.

- <Feature Abort> is also used as a response to the <Abort> message during testing, see CEC 12.4

CEC 12.4 Abort

The <Abort> message shall be implemented as a Follower in all devices except pure CEC Switches and is used during testing only. It shall be directly addressed to a specific device, which shall respond with a <Feature Abort> message. In this instance, any valid [Abort Reason] operand may be returned.

- A device shall ignore an <Abort> message which is broadcast.

CEC 13 CEC Features Description

This section describes the message transfer and additional details for a number of common features enabled by CEC. Note that where a feature is supported, all messages within that feature should be implemented.

CEC 13.1 One Touch Play

CEC 13.1.1 Messages

The following messages are used for the One Touch Play feature:

<Active Source>, <Image View On>, <Text View On>

CEC 13.1.2 Feature Description

The One Touch Play feature allows a device to be played and become the active source with a single button press.

A device shall send the message <Image View On> to the TV only when it needs to indicate that its output should be displayed on the screen. If the TV is in a Text Display state (e.g. Teletext) it should switch to the Image Display state. If a menu is being displayed on the TV it should remain on screen.

A device may alternatively send the message <Text View On>. This message has the same functionality as <Image View On> with the addition that any menus that the TV is displaying should be removed.

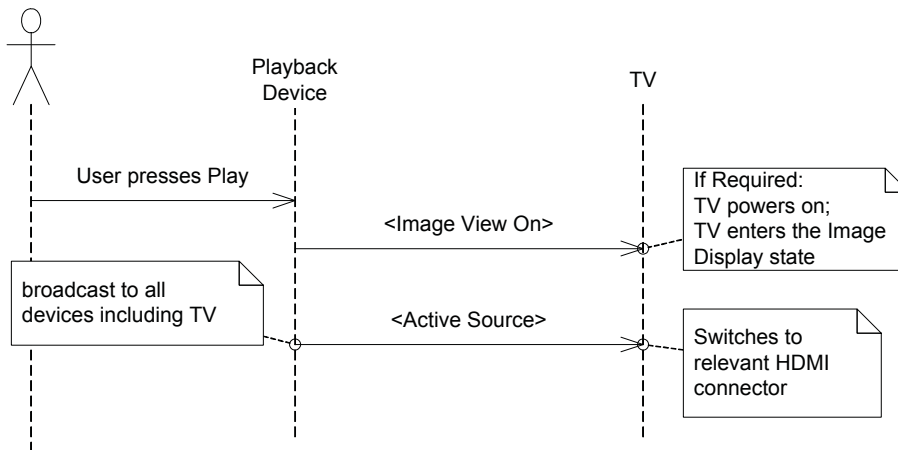

CEC Figure 9 A typical scenario illustrating the One Touch Play feature

When a source needs to display its output on the TV, it should send an <Image View On> message whenever it sends an <Active Source> message, as the source is not aware of the current Standby status of the TV.

The source shall send the associated <Active Source> message only when it has some stable video for display to the user.

If the TV is brought out of the Standby state by an <Image View On> message, it should buffer <Active Source> messages received while it is powering up so that it may select the correct input (if necessary). If

this is not possible, or none were received, then it should enquire which device is the active source by sending a <Request Active Source> message.

Whenever a device becomes the new source device it shall broadcast an <Active Source> message. The currently active source device loses its active source status and should then take appropriate action, for example, it may pause if it is playing media.

Note: there is a special case when a TV switches to its internal tuner or to another non-HDMI source (eg Y/C, or a SCART socket on European market sets). In this case, it is the TV which broadcasts the <Active Source> message with address 0.0.0.0.

Note that it is mandatory for a source to implement at least one of <Image View On> or <Text View On>.

CEC 13.1.3 Behaviour with Earlier Versions

When sending this Message	From this HDMI Version 1.3 or 1.2a Device	To this HDMI Version 1.3a Device	Possible behaviour
<Image View On>	Any source	TV	The TV may not keep its current menu on the screen
<Text View On>	Any source	TV	The TV may not remove its current menu on the screen
<Active Source>	Any source	Any	The use of <Active Source> by devices before 1.3a was recommended, not mandatory.

CEC 13.2 Routing Control

CEC 13.2.1 Messages

The following messages are used for the Routing Control feature:

<Active Source>, <Inactive Source>, <Request Active Source>, <Set Stream Path>, <Routing Change>, <Routing Information>

CEC 13.2.2 Feature Description

This feature is used to control the routing of the HDMI network, by controlling CEC Switches. In general whenever a device starts being streamed to the TV it shall send an <Active Source> message (see One-Touch Play in section CEC 13.1).

On receiving an <Active Source> message, CEC Switches between the device and the TV shall become active (if necessary) and switch (if required) to ensure that there is an active path from the device at the physical address specified to the TV. Devices which have other functionality and which also incorporate a CEC Switch, such as an amplifier with several HDMI inputs, need only bring the Switch part out of the Standby state as a response to the <Active Source> message, leaving the other functionality (eg amplifier) still in the Standby state.

If a device (other than a CEC Switch) is currently the active source, then it shall lose its active source status on receiving an <Active Source> message from another device and should act accordingly, for example it may pause if it is playing media.

When a device comes out of standby or a (mains) off state, it may broadcast a <Request Active Source> message to discover if any other device is currently acting as the active source, see One Touch Play in section CEC 13.1. On receiving a <Request Active Source> message, the active source device shall respond by broadcasting an <Active Source> message. A particular instance of this rule is when a TV comes out of standby some time after its source device(s). In this case it may not know the currently active source and it may not know which is the relevant connector to use (if the TV has multiple HDMI connectors), because it was in standby or powering up when the device sent its <Active Source> message. Here, the <Request Active Source> and the corresponding <Active Source> response are used to identify the relevant connector.

When the System Audio Control feature is started by an Amplifier (eg as a result of a local user command on the Amplifier), the <Request Active Source> shall be sent by the Amplifier to discover the currently active source in order present the relevant sound for the video (see CEC 13.15). This is not necessary when the System Audio Control feature is not active.

The user may select a device to view via the TV user interface. In contrast to the <Active Source> message (which is sent by the current active source to the TV), the <Set Stream Path> is sent by the TV to the source device to request it to broadcast its path using an <Active Source> message. In this case, the TV should broadcast a <Set Stream Path> message with the physical address of the device it wants to display as a parameter. Any CEC Switches between the device and TV shall switch (if required) to ensure the device is on the active AV path. This feature also ensures that non-CEC-compliant devices in the network can be switched to, if for instance they have been manually set up in the TV menu. A CEC device at the location specified by the <Set Stream Path> message should come out of standby (if necessary). If and when it has stable video to display, it shall broadcast an <Active Source> message and begin streaming its output.

Note: there is a special case when a TV switches to its internal tuner or to another non-HDMI source (eg Y/C, or a SCART socket on European market sets). In this case, it is the TV which broadcasts the <Active Source> message with address 0.0.0.0.

When the user has specifically sent the currently active device only to standby (eg as the result of a user action using the device's local control, such as its own remote controller), it should send an <Inactive Source> message with its own Physical Address as an operand. It is a manufacturer decision to decide the TV's response: it may, for example, display its own internal tuner, or select another device for display. In these cases, the TV should send a new <Active Source> message with its own physical address (0.0.0.0, when displaying its own internal tuner), or send a <Set Stream Path> to a new device for display. Note that an <Inactive Source> message can also be sent when the Source Device has no video to be presented to the user, even if the device is not in the standby state.

In the case that the user manually switches a CEC Switch it shall broadcast a <Routing Change> message (see below for exceptions with non-HDMI sources). This will inform all devices in the network that the current active route below the Switch has changed. The device that has been deselected by a Switch loses its active source status and enables it, for instance, to pause if it is playing media.

If a CEC Switch is at the new position indicated by the <Routing Change> message then it shall broadcast a <Routing Information> message with the physical address of its current active path. If a CEC Switch at the new position receives a <Routing Information> message then it shall broadcast a <Routing Information> message to indicate it's current active path. In this way the all CEC Switches are aware of the route to the new source and the last <Routing Information> message contains the complete route (address) to the new source.

When using non-HDMI sources:

- If a CEC Switch has non-HDMI inputs and the currently selected input is a non-HDMI source, the CEC Switch should not send a <Routing Information> message in response to a <Routing Change> or <Routing Information> message. For example, if the CEC Switch is already using an analogue input, then the CEC Switch should not send a <Routing Information> message in response to a <Routing Change> or <Routing Information> message.
- If a device (such as a TV or amplifier) with a CEC Switch is changed by the user from an HDMI source to a non-HDMI source (eg to the internal TV tuner or external SPDIF input on an Amplifier), then it should not send a <Routing Change> message.
- When switching from a non-HDMI source to an HDMI source, then the device should send a <Routing Change> message to determine the HDMI path below the Switch.

Optionally, if the TV detects that the active source device has been de-selected by changing the Switch it may either switch to an internal service or may send a <Set Stream Path> message to the device at the new location to indicate that it should become the new active source. In this case, the TV shall wait for a minimum of 7 nominal data bit periods and a recommended maximum of 500ms before reacting to a <Routing Change> or <Routing Information> message to allow CEC Switches to relay any <Routing Information> messages that are required.

The following diagram shows an example of the message flow when a user manually switches a CEC Switch. (CEC Switches are shown filled).

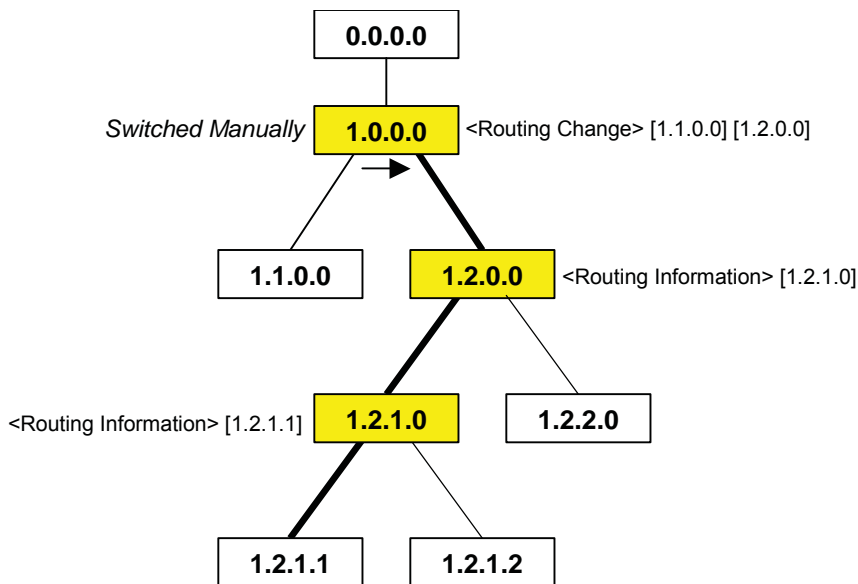

CEC Figure 10 Example message flow, when a CEC Switch is manually switched

CEC 13.2.3 Behaviour with Earlier Versions

The <Inactive Source> message is new in version 1.3a.

CEC 13.3 System Standby

CEC 13.3.1 Messages

The following message is used for the System Standby feature:

<Standby>

CEC 13.3.2 Feature Description

The broadcast message <Standby> can be used to switch all CEC devices to standby. A typical scenario where the user sets a the whole system to standby is shown below:

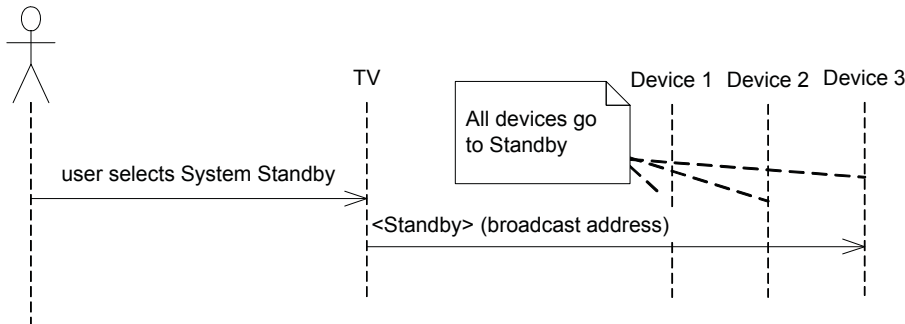

CEC Figure 11 A typical scenario for the broadcast (system) Standby feature

The whole system may be set to standby by broadcasting the <Standby> message. It is manufacturer dependent on how to differentiate between a standby message for a single device, e.g. a STB, and System Standby message (broadcast to the whole system). For example, the system or broadcast <Standby> message may be sent as the result of a long press on the local or remote control standby button.

A device can switch another single device into standby by sending the message <Standby> as a directly addressed message to it.

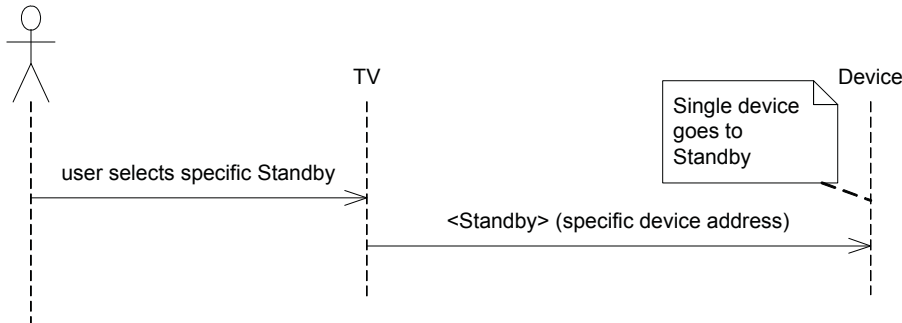

CEC Figure 12 A typical scenario for the Standby feature to a specific device

A <Standby> message is not a toggle and can only send a device to the Standby state: other messages shall be used to activate a device, i.e. bring a device out of the Standby state.

A <Standby> message should not interrupt any background tasks such as a recording - see Timed Recording, section CEC 13.5.3.

Devices can ignore <Standby> messages if they are in a state where going into standby is not the appropriate action or due to device limitations it is not possible to go to the Standby state. For example:

- The device is recording;
- The device only has a mechanical power switch;
- It only provides limited facilities for external control of its power;
- The Standby function is disabled;
- It is a device, such as a PC, which is performing other functions that should be left running;
- High priority services, such as the reception of emergency announcements or similar, shall continue.

CEC 13.3.3 Behaviour with Earlier Versions

When sending this Message	From this HDMI Version 1.3a Device	To this HDMI Version 1.2a or 1.3 Device	Possible behaviour
<Standby>	Any	Source or recorder	When a <Standby> message is sent during a recording: - the target might not ignore the <Standby> message; - the target might not go to the Standby state after a recording. (These were manufacturer decisions clarified in 1.3a.)

CEC 13.4 One Touch Record

CEC 13.4.1 Messages

The following messages are used for the One Touch Record feature:

<Record Off>, <Record On>, <Record Status>, <Record TV Screen>

CEC 13.4.2 Feature Description

This feature allows the user to easily start a recording of the source that is being displayed on the TV, just by selecting a Recording Device and giving the record command. It is not always possible to carry out a One Touch Record as it depends on what source is currently being displayed. It is primarily used for the instant recording of a tuner service, or the recording of another device (e.g. Camcorder) connected externally to the Recording Device

Either the TV or the Recording Device may initiate the One Touch Record Feature, for example by selecting a menu option on the TV or by pressing record on the Recording Device.

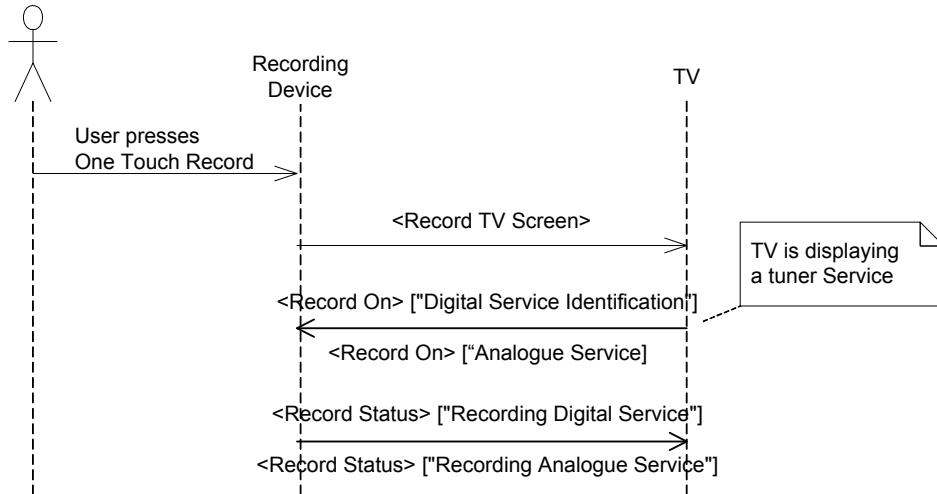

CEC Figure 13 A typical scenario for the One Touch Record feature

In the event of the Recording Device initiating the feature, it should send a <Record TV Screen> message to the TV. On receipt of the <Record TV Screen> message by the TV, or if the user initiates the One Touch Record feature via the TV, the TV shall react as follows:

- If the TV is currently displaying an internal tuner service, it shall respond with a <Record On> [“Digital Service”] [Digital Service Identification] message or a <Record On> [“Analogue Service”] [Analogue Broadcast Type] [Analogue Frequency] [Broadcast System] message.
- If the Recording Device is the current active source device, then the TV shall respond with a <Record On> [“Own source”] message.
- If the TV is currently displaying an external input and it knows the Physical Address of the external source (eg it has a map of which external devices are connected), then the TV may send a <Record On>[External Physical Address] message. The TV may alternatively send a <Record On>[External Plug Number] message if it knows the relevant plug number on the recorder for the external source.
- If the TV is currently displaying some other source, it shall respond with a <Feature Abort> [“Cannot provide source”] message, or do nothing if initiated via the TV.

On receipt of a <Record On> message the Recording Device shall act as follows:

- If [“Digital Service”] or [“Analogue Service”] is indicated and the device can record that service using the information that was sent, the device shall change to that service and start recording. If the device does not have the indicated type of tuner, then it should respond with a <Record Status> with an operand of [“No recording – unable to record Digital Service”] or [“No recording – unable to record Analogue Service”].
If the recorder has a suitable tuner, but is not able to select a service because the requested parameters are invalid or out of the range of the tuner, then it should return “No recording – Unable to select required service”.
- If [“Own source”] is indicated, then it shall attempt to record whatever it is currently displaying, e.g. an external connection such as a camcorder or the service it is currently tuned to.
- If [“External Plug”] or [“External Physical Address”] is indicated, the recorder should switch to the connector indicated by the External Plug number, or the connector which has the input from the device identified by the external Physical Address, and return a status of “Recording External input”. If [External Plug] or the [External Physical Address] is invalid, the device should return “No recording – invalid External plug number” or “No recording – invalid External Physical Address” respectively.

The Recording Device shall respond with the message <Record Status> to indicate if recording has begun, or a reason why recording has failed. If the recording failed to start, the TV should inform the user, with the reason, or take other appropriate action. Note that it may take several seconds before a recorder is able to send an accurate <Record Status> after receiving a <Record On> message.

A recording initiated by a <Record On> message may be stopped at any time by sending a <Record Off> message. The Recording Device should then stop recording immediately. The recorder may optionally send a <Record Status> message in response to a <Record Off> message. In this case, the recorder may indicate that the recording was terminated normally by the <Record Off> message, or that the recording had already terminated, eg because there was insufficient space available on the media.

When a recorder is making a recording, the system <Standby> message should not interrupt a recording in progress. If the recorder receives a <Standby> message during the recording, it should react to the <Standby> message when the recording has finished unless it is the Active Source at the end of the recording.

The TV should ignore a <Record TV Screen> message that comes from a non-Recording Device address, however it shall accept the message from a 'Reserved' address (a future device type).

CEC 13.4.3 Behaviour with Earlier Versions

When sending this Message	From this HDMI Version 1.3a Device	To this HDMI Version 1.2a or 1.3 Device	Possible behaviour
<Record ON>	TV	Recording Device	<Feature Abort>, when specifying a [Record Source] other than "Own Source"
<Record Status > after a <Record Off> message	Recording Device	TV	<Feature Abort> as sending a <Record Status> in this case is new in 1.3a

When sending this Message	From this HDMI Version 1.2a or 1.3 Device	To this HDMI Version 1.3aDevice	Possible behaviour
<Record ON>	TV	Recording Device	<Feature Abort> as <Record ON> is optional in 1.3a

CEC 13.5 Timer Programming

CEC 13.5.1 Messages

The following messages are used for the Timer Programming feature:

<Clear Analogue Timer>, <Clear Digital Timer>, <Clear External Timer>, <Set Analogue Timer>, <Set Digital Timer>, <Set External Timer>, <Set Timer Program Title>, <Timer Cleared Status>, <Timer Status>

CEC 13.5.2 Feature Description

This feature allows a device (e.g. the TV) to set a timer recording on a Recording Device. It may for example be used to set timer blocks of a Recording Device via a TV menu or via an EPG.

A device, such as the TV, may set or clear an individual timer block of a Recording Device. The Recording Device will respond to indicate if the timer was successfully set/cleared.

A timer block is set in the Recording Device by sending it a <Set Analogue Timer>, <Set Digital Timer> or a <Set External Timer> message, according to the type of service to be recorded.

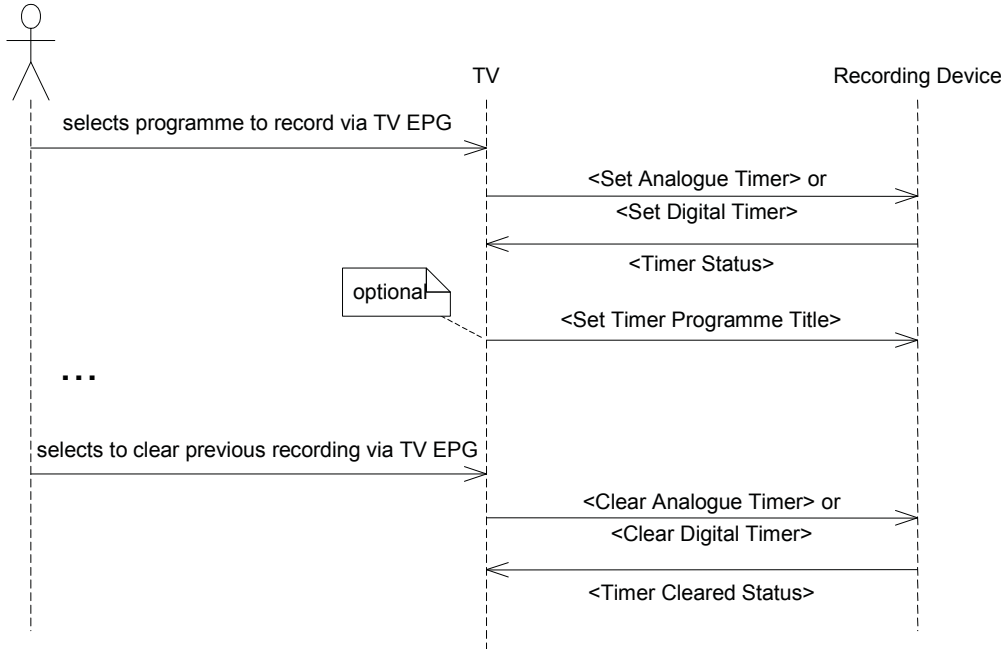

CEC Figure 14 A typical scenario for setting a Timer Record Block

The Recording Device shall respond to the TV to indicate that a Timer was successfully programmed with a <Timer Status> message. For instance, there may be a conflict with an existing Timer, or the tuner in the Recording Device might not be of the correct Type (eg transmission system and/or CA).

The Recording Device may optionally include an estimate of the duration available on the media when:

- There is not, or may not be, sufficient space available for recording; or
- The timer was not successfully programmed because the event already exists.

Note that duration estimate may not be accurate with variable bitrate recordings, such as with a broadcast TV stream.

It is also possible to transfer the program title of a timer block (where for instance a timer is set via an EPG). To achieve this a device may send a <Set Timer Program Title> message directly after sending <Set Analogue Timer>, <Set Digital Timer> or <Set External Timer>. The Recording Device may then store the program title along with the timer information. If the Recording Device does not support program titles, then it shall Feature Abort an incoming <Set Timer Program Title> message.

When a recorder is making a recording, the system <Standby> message should not interrupt a recording in progress. If the recorder receives a <Standby> message during the recording, it should react to the <Standby> message when the recording has finished unless it is the Active Source at the end of the recording.

CEC 13.5.3 Performing a Timed Recording using another device as source

When recording using another source device, eg recording a separate STB, the signal connection to the recorder will be made using another link such as an analogue connection or a SCART lead.

The <Set External Timer> message can be used to set a Timer in a Recording Device so that it uses an external (non-HDMI) connection as the source. There are two methods of specifying which connector the recorder should use: External Plug and External Physical Address, as specified in [External Source Specifier]:

- When “External Plug” has been specified, the recorder switches to the indicated plug number. Note that, in this case, the user (or an application in the TV) will have to supply the relevant External Plug number.
- When “External Physical Address” has been specified, the recorder switches to the relevant connector for the external device identified by the External Physical Address. Note that, in this case, the mapping of External Physical Address to recorder input connector is stored in the Recording Device. This mapping is usually made at installation time.

When the Recording Device starts a timed recording, it shall send a <Record On> message to the external tuner (STB) with the relevant operand to select the required service (analogue, digital or own source). Operation of this message is as described in the One Touch Record feature (see section CEC 13.4) and will cause the external device to come out of the Standby state if necessary. In this case, it shall do so “silently” without sending any <Image View On> or <Active Source> messages and shall provide an output on the separate link (eg SCART).

If the recorder initiated a recording using a <Record On> message to an external source, it shall also send a <Record Off> message to that source when the recording has finished, or when the recorder was unable to complete a recording for any reason (eg it has run out of media).

If the Source Device receives a <Standby> message during the recording, it shall ignore it for the duration of the recording and go to the Standby state after it has completed the recording (ie after receiving the <Record Off> message), unless it is the Active Source at the end of the recording.

CEC 13.5.4 Behaviour with Earlier Versions

This feature was introduced in HDMI version 1.3a. Devices conforming to HDMI version 1.3 or earlier will <Feature Abort> all messages sent by an Initiator for this feature.

CEC 13.6 System Information

CEC 13.6.1 Messages

The following messages are used for the System Information feature:

<CEC Version>, <Get CEC Version>, <Get Menu Language>, <Give Physical Address>, <Polling Message>, <Report Physical Address>, <Set Menu Language>.

CEC 13.6.2 Feature Description

This feature allows devices to automatically use the same OSD and Menu language settings as the TV and also for a TV to discover the current language when it is being installed.

When a source device is powered on, it should send a <Get Menu Language> message to the TV. The TV shall then respond as shown below with a <Set Menu Language> message.

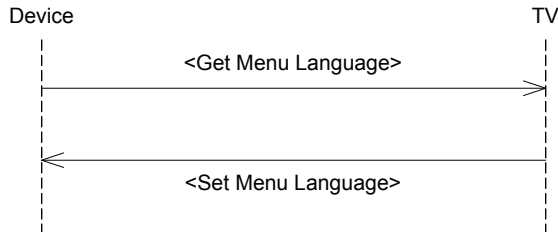

CEC Figure 15 Message exchange when getting the TV's menu Language

When the user changes a menu language setting on the TV, it shall send a <Set Menu Language> message containing the currently selected menu [Language], as shown below.

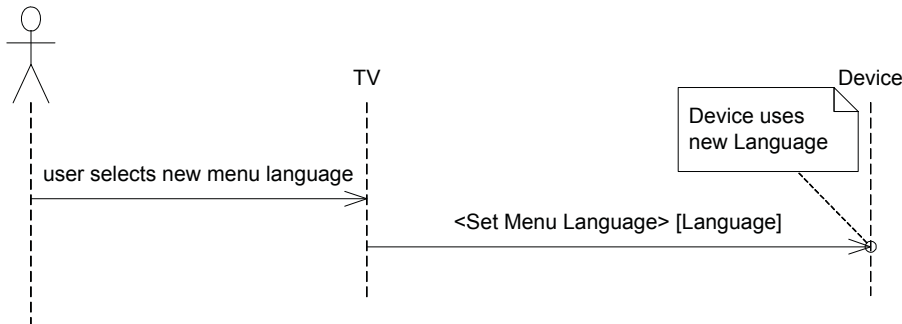

CEC Figure 16 A typical scenario when a menu language setting within the TV is modified

On receipt of the <Set Menu Language> message, the device shall attempt to use the newly selected [Language] for Menus and OSDs.

Note that a device might receive a <Set Menu Language> message even when the language has not been changed. A device shall ignore any of the above messages that come from an initiator address other than 0 (the TV).

During the installation of a TV, the <Get Menu Language> message may be sent by the TV to another device to discover what language has been set on that device.

When identifying a language, the Bibliographic codes of ISO/FDIS 639-2 [ref 1n] shall be used.

In the case of Chinese, codes "zho" and "chi" are used. Where a device supports both Simple and Traditional characters, "zho" should be used for Simple characters and "chi" for Traditional characters. Where a device only supports one set (either Simple or Traditional), then the other code should default to the same character set. For example, if a device only supports Simple characters ("zho") it should also use these when the language is set to "chi" (Traditional).

A device can ask another device to indicate which version of CEC the target device supports, by sending a <Get CEC Version> message. The target device responds with a <CEC Version> message, which includes the relevant [CEC Version] operand. Note that the CEC version supported shall correspond with the relevant HDMI version, ie a device claiming support for CEC version 1.3a shall also support HDMI 1.3a.

CEC 13.6.3 Additional Information

The <Polling Message> is used to detect the presence or absence of a device within the system, see 6.1.3. It is also used for allocating logical addresses as detailed in CEC 10.2.1.

The <Report Physical Address> message is used by a device to broadcast its physical address to all other devices in the system. By using the logical and physical addresses, any other device is able to derive the physical connectivity of the network. A device may request the physical address of another device by sending a directly addressed <Give Physical Address> message to it.

CEC 13.6.4 Behaviour with Earlier Versions

<Get CEC Version> and <CEC Version> are new messages for CEC Version 1.3a.

CEC 13.7 Deck Control

CEC 13.7.1 Messages

The following messages are used for the Deck Control feature:

<Deck Status>, <Give Deck Status>, <Deck Control>, <Play>

CEC 13.7.2 Feature Description

This feature allows a Playback Device (a deck or disc player or recorder) to be controlled by another device (e.g. the TV). Messages are also provided to allow a device to find out the status of the Deck; this allows, for example, a TV to keep its user interface synchronized with the status of the Deck.

A device may query the status of a deck with the <Give Deck Status> command. The deck should respond with a <Deck Status> message.

A device may control a Deck with the <Play> and <Deck Control> messages. These messages may be initiated after a user command. The Deck shall act upon the command that it receives within the messages <Play> and <Deck Control>. It is the equivalent of the user selecting the command local to the Deck. If the deck cannot carry out the command (e.g. it has no media when trying to play) it should respond with a <Feature Abort> ["Not in correct mode to respond"] message.

If the deck is in standby and receives a <Deck Control> ["Eject"] or <Play> ["Play Forward"] message, it should power on and act on the message. It is up to the manufacturer to decide if the device should power on when receiving any other <Deck Control> or <Play> messages.

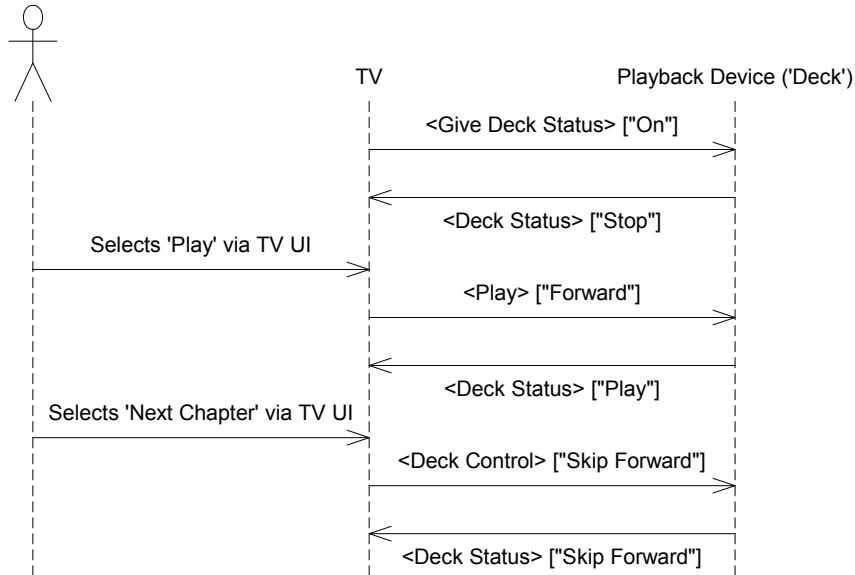

CEC Figure 17 A typical scenario for the Deck Control feature

The effect of the <Play> [Play Mode] operands "Fast Forward xx" and "Fast Reverse xx" will depend on the target device. For a disc-based system (eg DVD, Hard Disk), these will usually produce a picture at the required speed and direction. However, for a tape deck, the previous deck state may affect how this message is executed so that a picture may not always be available.

The effect of the <Deck Control> [Deck Control Mode] operands "Skip xx" will also depend on the target device. For a disc-based system, this will cause the disc to skip to the next Chapter. For a tape, this will cause the tape to go to the next marker without displaying a picture.

CEC 13.7.3 Behaviour with Earlier Versions

There are no differences between a CEC version 1.3a device and a device implementing earlier versions of CEC.

CEC 13.8 Tuner Control

CEC 13.8.1 Messages

The following messages are used for the Tuner Control feature:

<Give Tuner Device Status>, <Record On>, <Select Analogue Service>, <Select Digital Service>, <Tuner Step Decrement>, <Tuner Step Increment>, <Tuner Device Status>

CEC 13.8.2 Feature Description

This feature allows a device (e.g. the TV) to control another CEC device's tuner.

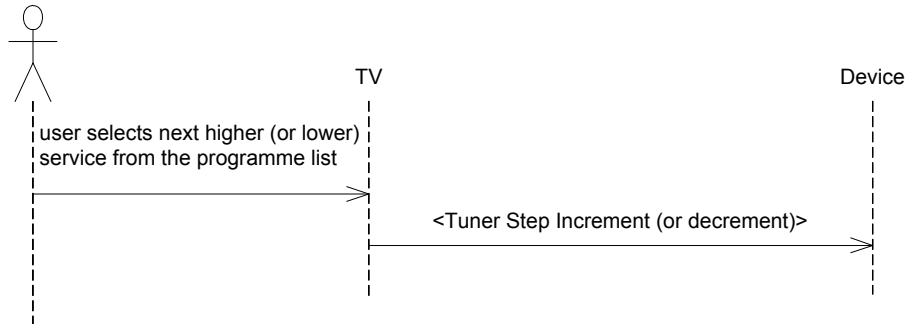

CEC Figure 18 A typical scenario for selecting a new Service

A device can control a CEC Device's tuner using the <Tuner Step Increment> and <Tuner Step Decrement> messages. If a device receives the <Tuner Step Increment> or <Tuner Step Decrement> message then it should select the next highest or next lowest service in its service list. The tuner device can interpret the messages as it chooses, for example, it may only cycle through channels included in the user's list of favorites.

A device can select a digital service on a tuner device by sending the <Select Digital Service> message. The tuner device shall then attempt to tune to that digital service and stream its output on the HDMI connection. If the specified digital service is not supported on the device then it should send a <Feature Abort> ["Invalid operand"] message. If the tuner device cannot select that digital service (e.g. if it is recording), it should respond with a <Feature Abort> ["Refused"] message. In a similar way, an analogue service may also be selected using the <Select Analogue Service> message.

A device may query the status of a tuner device by sending a <Give Tuner Device Status> message. The tuner device shall respond by sending a <Tuner Device Status> message indicating if it is currently displaying its tuner and the service that is currently selected.

A <Record On> message may be sent to a tuner when making an external recording. For details, see CEC 13.5.3.

CEC 13.8.3 Behaviour with Earlier Versions

<Select Analogue Service> is a new message for CEC Version 1.3a.

CEC 13.9 Vendor Specific Commands

CEC 13.9.1 Messages

The following messages are used for the Vendor Specific Commands feature:

<Device Vendor ID>, <Give Device Vendor ID>, <Vendor Command>, <Vendor Command With ID>, <Vendor Remote Button Down>, <Vendor Remote Button Up>

CEC 13.9.2 Feature Description

This feature allows a set of vendor specific commands to be used to communicate between devices.

A device that supports vendor specific commands shall store a Vendor ID. A device shall broadcast a <Device Vendor ID> message after a successful initialization and address allocation to inform all other devices of its vendor ID. A device may request the Vendor ID of another device by sending a <Give Device Vendor ID> message to it. The follower shall respond by broadcasting a <Device Vendor ID> message. In this way any device can determine the vendor of another device.

A device shall attempt to transmit a directly addressed <Vendor Command> to another device only if it has obtained or received the Vendor ID of that device and it recognizes that Vendor ID. A device should only send a <Vendor Command> if it has previously sent a <Device Vendor ID> message.

A follower device may accept a <Vendor Command> from an initiator of the same Vendor ID. With the agreement of the vendors involved, it is also possible for a device to accept a <Vendor Command> from devices made by other vendors. The follower may accept a <Vendor Command> only if the initiator's Vendor ID matches a Vendor ID on the follower's internal list of acceptable Vendor IDs. It should ignore all messages coming from devices with Vendor IDs which it does not recognize.

If an initiator device wants to send a <Vendor Command> and it does not know the Vendor ID of the follower device, the initiator device shall send a <Give Device Vendor ID> message to the follower device before it sends the <Vendor Command>. The follower device may respond to the received <Vendor Command>. It should only respond without previously sending a <Give Device Vendor ID> message if the follower device already knows the Vendor ID of the initiating device.

The <Vendor Command With ID> message may be broadcast as well as directly addressed. This differs from the <Vendor Command> in that the first 3 bytes of the payload carry a Vendor ID which identifies the vendor or entity which defined the command. Devices which receive the <Vendor Command With ID> and which do not accept the Vendor ID contained in the command shall ignore this command and shall respond with a <Feature Abort> if the message was directly addressed to that receiving device.

It is possible to send vendor specific remote control commands using the <Vendor Remote Button Down> and <Vendor Remote Button Up> messages.

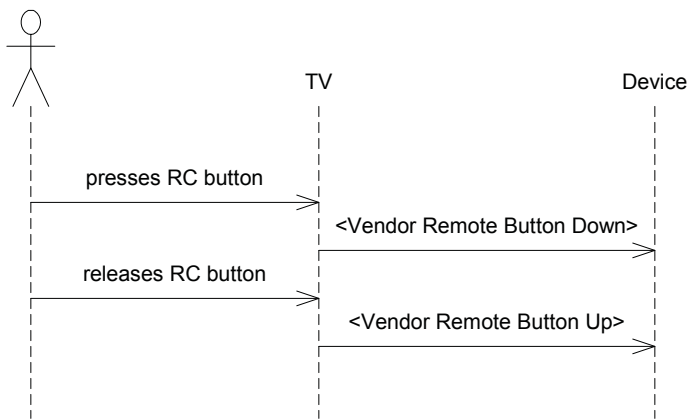

CEC Figure 19 The messages sent in the Vendor Specific Commands feature

In addition it is possible to send other (non remote control key) vendor specific messages using the <Vendor Command> and <Vendor Command With ID> messages. The message parameter(s) can be used to communicate any additional (vendor defined) messages and data.

CEC 13.9.3 Behaviour with Earlier Versions

<Vendor Command With ID> is a new message for CEC Version 1.3a.

In CEC Version 1.3a, by agreement of the vendors involved, <Vendor Command> messages may be used by devices which do not have the same Vendor ID.

CEC 13.10 OSD Display

CEC 13.10.1 Messages

The following message is used for the OSD Display feature:

<Set OSD String>

CEC 13.10.2 Feature Description

This feature allows a device to transfer a text string to the TV for On Screen Display. The <Set OSD String> message is used to transfer the text string to the TV.

A text string may be displayed for a default period (i.e. 5 seconds) or until explicitly cleared. In the latter case the device should send another <Set OSD String> message to clear the text when it is appropriate.

The TV should display the whole string unless it is in an unsuitable state, in which case it should generate a <Feature Abort> message.

If a new <Set OSD String> message is received when an OSD String is already being displayed, it should overwrite the existing string. OSD Strings generated locally within the TV may also overwrite any messages sent via the <Set OSD String> message.

CEC 13.10.3 Behaviour with Earlier Versions

There are no differences between a CEC version 1.3a device and a device implementing earlier versions of CEC.

CEC 13.11 Device OSD Name Transfer

CEC 13.11.1 Messages

The following messages are used for the Device OSD Name Transfer feature:

<Give OSD Name>, <Set OSD Name>

CEC 13.11.2 Feature Description

This feature is used to request the preferred name of a device to be used in any on screen display (e.g. menus), which reference that device. A device (e.g. the TV) may request another devices name by sending a directly addressed <Give OSD Name> message to it. If the device supports this feature it shall respond with a <Set OSD Name> message. The devices name should then be stored and used in any future on screen references to it.

A TV may send a <Give OSD Name> message whenever it discovers a new device that has been connected.

CEC 13.11.3 Behaviour with Earlier Versions

A TV conforming to CEC Version 1.3a may not send a <Give OSD Name> message when it discovers a new device.

CEC 13.12 Device Menu Control

CEC 13.12.1 Messages

The following messages are used for the Device Menu Control feature:

<User Control Pressed>, <User Control Released>, <Menu Request>, <Menu Status>

CEC 13.12.2 Feature Description

This feature allows device menus to be controlled via the TV remote control as if it was using its own remote control and allow the TV to be aware when another device has a menu on its display.

A device shall indicate that it is displaying a menu by sending a <Menu Status> ["Activated"] message to the TV. If the device leaves the menu it shall send a <Menu Status> ["Deactivated"] message to the TV. The TV should then handle incoming remote control commands internally (as it would normally).

The message <User Control Pressed> can be used to send incoming Remote Control commands from the TV to a device that it is displaying a menu. The <User Control Released> message should be sent on release of the RC button. If a device fails to acknowledge any <User Control Pressed> or <User Control Released> message when in the providing menu state, the TV can assume that it has been removed from the system and act accordingly. For more information on <User Control> see the Remote Control Pass Through feature description (CEC 13.13).

The TV may initiate a device's menu by sending a <Menu Request> ["Activate"] command. It may subsequently remove the menu by sending a <Menu Request> ["Deactivate"] message. The TV may also query a device's menu status by sending a <Menu Request> ["Query"]. The menu device shall always respond with a <Menu Status> command when it receives a <Menu Request>.

A new active source device shall send a <Menu Status> ["Activated"] message to the TV if it is displaying a menu. The TV shall assume that a new active source is not in a menu unless it receives this message after the <Active Source> message. The TV shall ignore a <Menu Status> message coming from a device that is not the current active source. A source device shall only send <Menu Status> commands when it is the current active source.

CEC 13.12.3 Behaviour with Earlier Versions

There are no differences between a CEC version 1.3a device and a device implementing earlier versions of CEC.

CEC 13.13 Remote Control Pass Through

CEC 13.13.1 Messages

The following messages are used for the Remote Control Pass Through feature:

<User Control Pressed>, <User Control Released>

CEC 13.13.2 Feature Description

This feature is used to pass remote control commands received by one device (typically the TV) through to another device in the network. This feature will typically be used in situations where a TV offers a remote control with additional modes for controlling other devices within the system. The TV will receive the RC command and pass the command through to the appropriate device within the system. In a system where there is more than one of a particular device type present, the initiator should decide (as locally specified) a default device to pass remote control commands to.

The initiator will send a <User Control Pressed> message when the remote control button is pressed. When the button is released a <User Control Released> message should be sent by the initiator. The initiator should not send repeated <User Control Pressed> messages for the same button press.

The initiator may send further <User Control Pressed> messages without interleaving <User Control Released> messages if a new button press occurs quickly after a button release. This has the same effect as sending a <User Control Released> for the first button.

If a follower has received a <User Control Pressed> message and it did not receive a <User Control Released> message (or another <User Control Pressed> message with a different [UI Command]) within 500ms, then it is recommended that the receiving device should assume that the button has been released and act accordingly.

A device that has initiated a <User Control Pressed> message shall ensure that it sends a <User Control Released> message before going into standby. In the event that the initiator of the message is powered off/disconnected before sending a <User Control Released> message, the follower will never receive the <User Control Released> message.

The <User Control Pressed> and <User Control Released> messages indicate that the user has pressed or released the relevant button on their remote control. The receiving device determines the response to these messages. For the non-Deterministic functions, the response may be device-dependant.

This method should not be used for sending commands other than true remote control pass through to another device as the actions taken by the other device are not defined in a consistent way.

CEC 13.13.3 Deterministic UI Functions

In CEC Table 27, codes 0x60 to 0x6D are identified as Functions. Unlike the other codes, which just pass remote control presses to the target (often with manufacturer-specific results), the Functions are deterministic, ie they specify exactly the state after executing these commands. Several of these also have further operands, specifying the function in more detail, immediately following the relevant [UI Command] operand. For further information on the additional operands below, refer to Table 26.

CEC Table 6 Deterministic UI Functions

UI Command Code	User Operation	Function	Additional Operands	Notes
0x60	Play Function	Specifies Play mode	[Play Mode]	1, 2
0x61	Pause-Play Function	Pauses playback. If repeated, the device shall remain in the paused state.		2
0x62	Record Function	Start recording. If repeated, the device shall remain in the record state without interrupting the recording.		2
0x63	Pause-Record Function	Pauses the recording. If repeated, the device shall remain paused.		2
0x64	Stop Function	Stops the media. If repeated, the device shall remain stopped.		2
0x65	Mute Function	Mutes audio output. If repeated, the audio shall stay muted.		
0x66	Restore Volume	Restores audio output to the value before it was muted.		
0x67	Tune Function	Identifies a broadcast channel number	[Channel Identifier]	1, 2
0x68	Select Media Function	Selects one Media within a device	[UI Function Media]	1, 2
0x69	Select A/V Input Function	Selects an A/V input	[UI Function Select A/V input]	1, 2
0x6A	Select Audio Input Function	Selects an Audio input	[UI Function Select Audio input]	1, 2
0x6B	Power Toggle Function	Toggles the device's power state (On / Standby)		2
0x6C	Power Off Function	Puts the device into the Standby state. If repeated, the device stays in the Standby state.		2
0x6D	Power On Function	Puts the device into the On (non-Standby) state. If repeated, the device stays in the active state		

Notes:

- 1 Functions with additional operands may also be used without the additional operand: in this case the behavior is manufacturer-specific.
- 2 During a recording or timed recording, a device may ask the user for confirmation of this action before executing it.

CEC 13.13.4 Behaviour with Earlier Versions

CEC Version 1.3a added [Record Stop], [Record Pause], [Power Off Function], [Power On Function] and [Data] UI commands. It also clarified the earlier [Power Function] to be [Power Toggle Function] (0x6B).

CEC 13.14 Give Device Power Status

CEC 13.14.1 Messages

The following messages are used for the Give Device Power Status feature:

<Give Device Power Status>, <Report Power Status>

CEC 13.14.2 Feature Description

Several messages, such as <Image View On> and <Play>, bring another device out of standby. The <Give Device Power Status> message is used to determine the current power status of a target device. The target device responds with a <Report Power Status> message containing the Power Status operand.

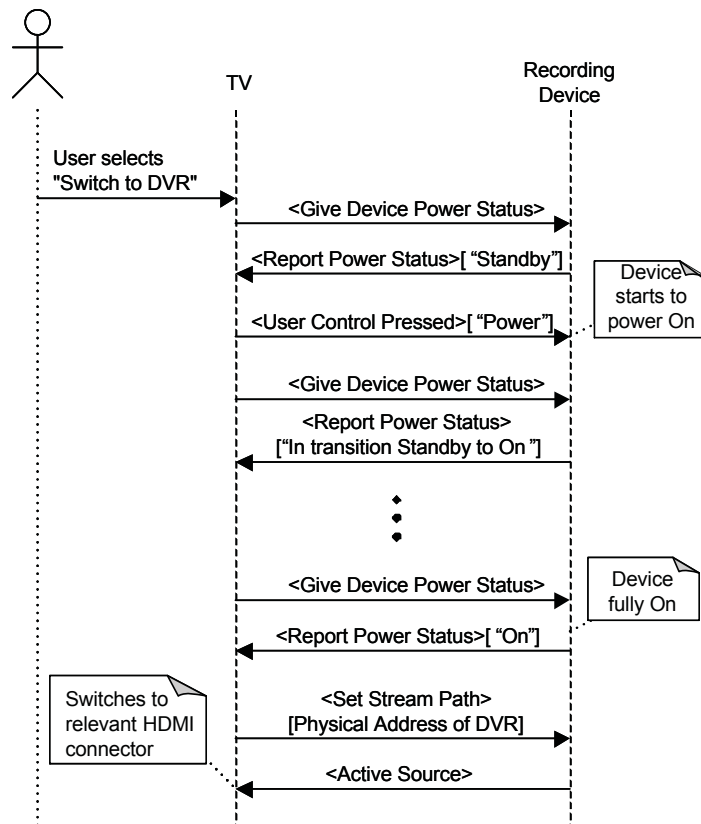

CEC Figure 20 A typical scenario for to discover the power status of a target device

Some devices, such as a Recording Device, may take some time before they have fully transitioned to the On state. A requesting device may poll the target device to determine when that device is fully On. In this case, the requesting device shall not send a <Give Device Power Status> message more frequently than once

every 0.5 seconds. It is not recommended that a requesting device polls another device until the first device has transitioned to a stable state.

CEC 13.14.3 Behaviour with Earlier Versions

When sending this Message	From this HDMI Version 1.3a Device	To this HDMI Version 1.2a or 1.3 Device	Possible behaviour
<Give Device Power Status>	Any	Any (except CEC Switches)	Device may <Feature Abort> as this was optional in 1.3 and before

CEC 13.15 System Audio Control

CEC 13.15.1 Messages

The following messages are used for the System Audio Control feature:

<Give Audio Status>, <Give System Audio Mode Status>, <Report Audio Status>, <Set System Audio Mode>, <System Audio Mode Request>, <System Audio Mode Status>, <User Control Pressed>, <User Control Released>.

CEC 13.15.2 Feature Description

This feature allows an audio amplifier to provide the audio for a source that is being displayed on a TV. When in this mode, the amplifier uses the same source as the video and provides the volume control function, instead of the TV, which mutes its speakers.

The feature can be initiated from a device (eg TV or STB) or the amplifier. In the case of initiation by a device other than the amplifier, that device sends an <System Audio Mode Request> to the amplifier, with the physical address of the device that it wants to use as a source as an operand. Note that the Physical Address may be the TV or STB itself. The amplifier comes out of standby (if necessary) and switches to the relevant input connector (see below concerning alternative connections). The amplifier shall then respond by sending a <Set System Audio Mode> [On] – see note below about addressing mode (direct or broadcast) of this command.

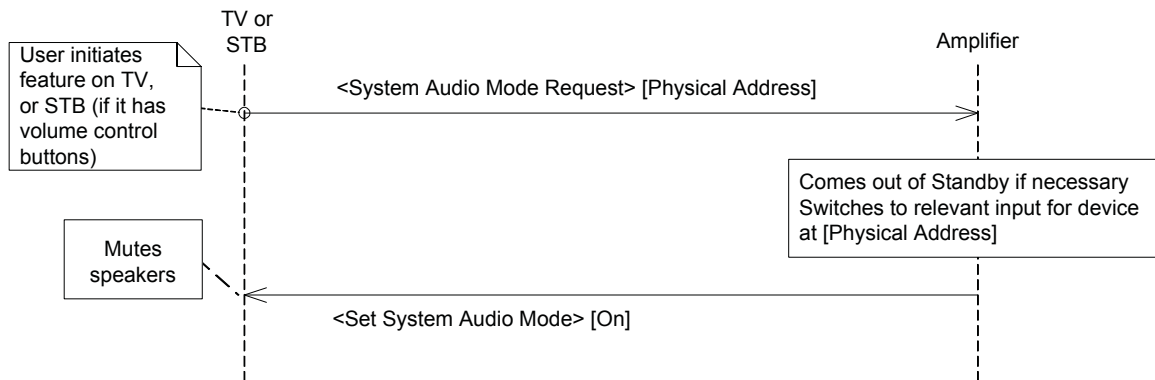

CEC Figure 21 A typical scenario for initiating the System Audio Control feature from a TV or STB

When the feature is initiated from the amplifier, it shall come out of standby (if necessary) and then shall discover which device is the currently active source, by broadcasting a <Request Active Source> message (note that it is not necessary for the amplifier to send a <Request Active Source> message if System Audio Control is not required). The active device shall respond with an <Active Source> message with its physical address and the amplifier then selects the relevant input for that device. The amplifier then starts the feature by sending <Set System Audio Mode> [On] message.

The <Set System Audio Mode> [On] message shall initially be directly addressed to the TV when a device other than the TV (eg amplifier or STB) has initiated the feature. This also allows the amplifier to discover if the TV implements the System Audio Mode feature. If the TV replies with a <Feature Abort> [Unrecognized Opcode] message (ie, it does not implement this message), then the amplifier shall not proceed further with the feature. If the TV does not <Feature Abort> the message, then the amplifier broadcasts a <Set System Audio Mode> [On] message to inform any other devices (eg STBs) that the feature has been started. Further <Set System Audio Mode> [On] messages may use the broadcast address, until the amplifier is put into the standby state. It is not recommended for the amplifier to store the fact that a TV supports this feature since this does not allow the amplifier to detect if the TV has been changed to a device that does not support this feature.

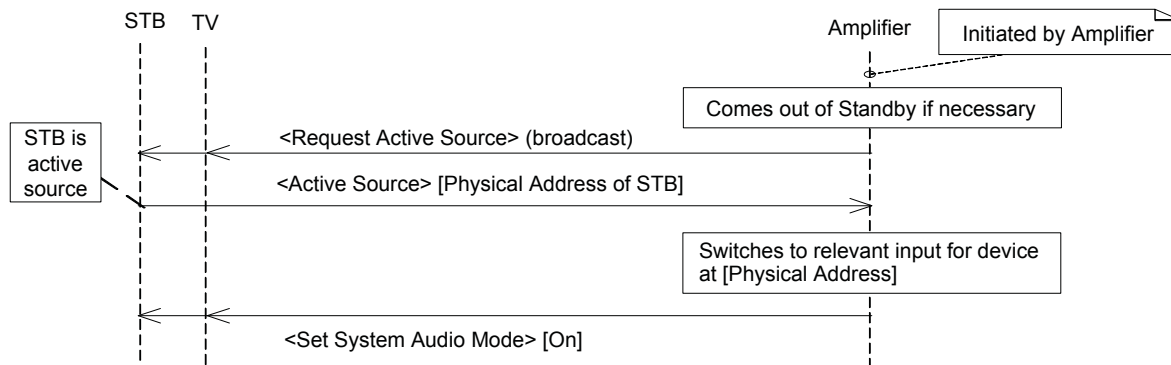

CEC Figure 22 A typical scenario for initiating the System Audio Control feature from an amplifier

When the TV receives the <Set System Audio Mode> [On] message, it mutes its speakers.

Stopping the feature can be initiated from the amplifier or other device. When the non-amplifier device (eg TV or STB) wants to stop the feature, it sends a <System Audio Mode Request> without a parameter to the amplifier. The amplifier shall respond by broadcasting a <Set System Audio Mode> [Off]. The amplifier can terminate the feature by broadcasting a <Set System Audio Mode> [Off].

When the TV receives the <Set System Audio Mode> [Off] message, it un-mutes its speakers.

Implementation of this feature shall be restricted to an amplifier and other devices that have volume control buttons such as a TV or STB.

When the System Audio Mode is On, the volume can be set using the volume control of the amplifier or other devices which have a volume control, such as the TV or a STB, using either the relevant user remote control or local controls on the device (eg physical Volume + / - keys or a rotary style control).

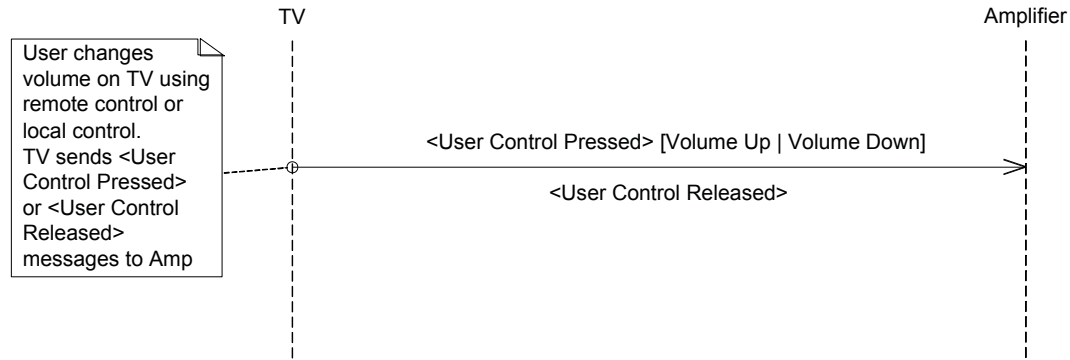

CEC Figure 23 Typical Operation of the volume control

Whenever the volume is changed by one of the above methods and the System Audio Mode is On, the device that received the User's volume commands sends out a <User Control Pressed> with the relevant [Volume Up] or [Volume Down] operand to the amplifier. When the User releases the control, the device sends a <User Control Released> message to the amplifier. For further information on the User Control messages, see CEC 13.13.

Note that the behavior of the system volume will be determined by the behavior of the amplifier's volume control.

When the user requires to mute or unmute the amplifier's speakers while the System Audio Mode is On, the device (such as a TV or STB) sends a User Control message with an operand of [Mute]. The behavior of the mute message is determined by the amplifier.

The <Give Audio Status> and <Report Audio Status> messages are mainly used so that the TV can display the audio status of the external amplifier, for instance the current Mute status or a Volume bar display. The <Give Audio Status > message is used to ask for the current audio status of a target amplifier. The target device responds with a <Report Audio Status> message containing the Audio Status operand.

After the relevant <User Control Pressed> message has been sent to adjust the volume, the amplifier may send <Report Audio Status> messages so that the TV may display a moving bar as the volume changes. In this case, it is not recommended to send a <Report Audio Status> message more frequently than once every 500ms.

When the amplifier is muted or un-muted, it should send a <Report Audio Status> message so that the TV may display the mute status.

While System Audio Mode is On:

- the TV or source shall not change their own internal volume levels;
- the amplifier's local and remote controls shall also be active and able to control its volume.

If the System Audio Mode is On, then the amplifier shall send a <Set System Audio Mode>[Off] message just before it goes into the Standby state in order to restore the volume function back to the TV. If the amplifier is brought out of standby by a <System Audio Mode Request> from a TV or source, the System Audio Mode shall become On; otherwise the System Audio Mode is Off.

When a TV or other source which implements the System Audio Control feature joins the system or comes out of standby, it shall request the current System Audio Mode status by sending a <Give System Audio Mode Status>. The amplifier, if active (ie out of the Standby state), shall respond with a <System Audio Mode Status> message indicating the current status. The TV or source shall behave according to the current System Audio Mode status, as described in the paragraphs above.

A TV will connect its audio to the amplifier via an alternative connection link such as analogue or S/PDIF. This is because the TV is at the end of an HDMI chain and so audio from the TV to the amplifier must be carried by the alternative link. It is also possible that other devices may connect their audio to the amplifier using an alternative link. In these cases it is the responsibility of the amplifier to switch to the device identified at a specified physical address (as indicated in an <System Audio Mode Request> or an <Active Source> message) and map that address to the actual connection in use, ie an HDMI connector or an alternative connector. In the case of a TV, the physical address of 0.0.0.0 will need to be mapped to the relevant alternative connector on the amplifier (eg analogue or S/PDIF). These mappings are usually made at installation time when the user identifies which connector and connection on the amplifier is used for each device.

CEC 13.15.3 Behaviour with Earlier Versions

This feature was introduced in HDMI version 1.3a. Devices conforming to HDMI version 1.3 or earlier will <Feature Abort> all messages sent by an Initiator for this feature.

CEC 13.16 Audio Rate Control

CEC 13.16.1 Messages

The following messages are used for the Audio Rate Control Feature:

<Set Audio Rate>

CEC 13.16.2 Feature Description

This feature allows the audio playback rate of a Source Device to be controlled by another device, e.g. an Audio System. A device may control the audio rate from a Source Device by sending a directly addressed <Set Audio Rate> message. Audio Rate Control is an exclusive function so that the Source Device can only be controlled by the one device that sent the <Set Audio Rate> message which started the Audio Rate Controlled function. It shall ignore any <Set Audio Rate> messages from other devices whilst it is in that state.

The audio rate controlled state is left when the controlling device sends a <Set Audio Rate> message with [Audio Rate] = "Rate Control Off" to the Source Device. The controlling device should send a <Set Audio Rate> command at least once every 2 seconds for active sensing. If a <Set Audio Rate> message is not received within 2 seconds or the status of the Source Device changes internally, then the Source Device shall quit the audio rate controlled mode. There are two control ranges, Wide and Narrow. When set to a specific range, the Source Device shall keep audio data streaming continuously even during a rate change transition, eg from Standard Rate to Fast Rate.

CEC 13.16.3 Behaviour with Earlier Versions

This feature was introduced in HDMI version 1.3a. Devices conforming to HDMI version 1.3 or earlier will <Feature Abort> all messages sent by an Initiator for this feature.

CEC 14 Device States

This section shows how CEC messages can change the states of a device.

CEC 14.1.1 Device States

The following is a list of states that each device type can be in. Each device should be in one and only one state for each line shown below.

- All Devices:** On, Standby, Off
- TV:** Image Display, Menu Display, Text Display
Device Menu Active, Device Menu Inactive
- Recording Device:** Recording, Not Recording
- Playback Device:** Deck Active, Deck Inactive
- Menu Providing Device:** Device Menu Active, Device Menu Inactive

CEC 14.1.2 State Changes

The following diagrams show the state transitions that are caused as a direct result of a device receiving a CEC message. Transitions between states that are not caused as a result of CEC messages are generally not shown, except where no CEC message can cause that transition.

CEC 14.1.3 All Devices

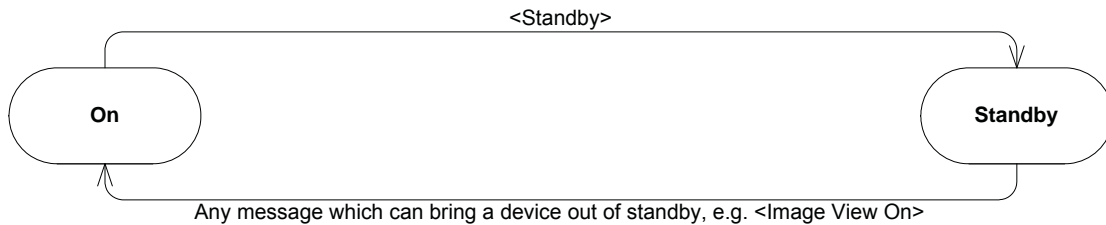

CEC 14.1.4 TV

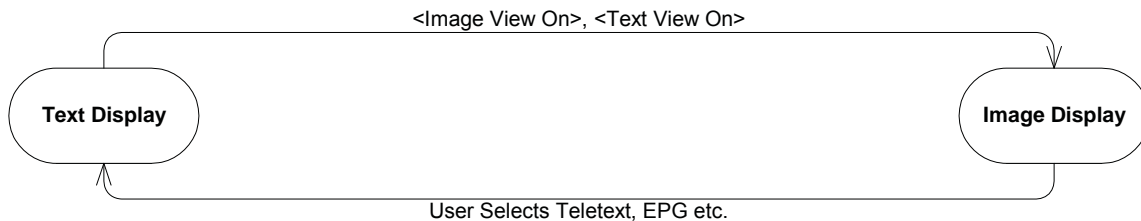

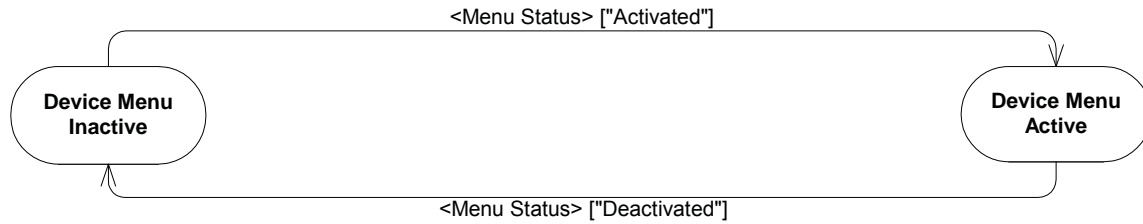
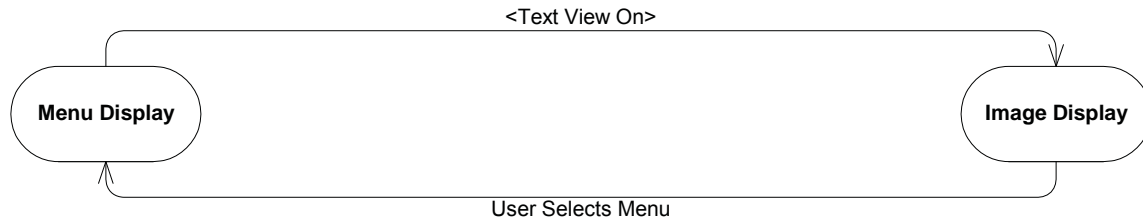

CEC 14.1.5 Recording Device

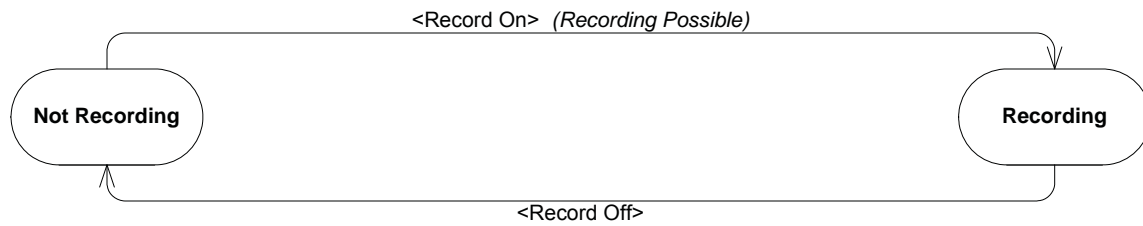

CEC 14.1.6 Playback Device

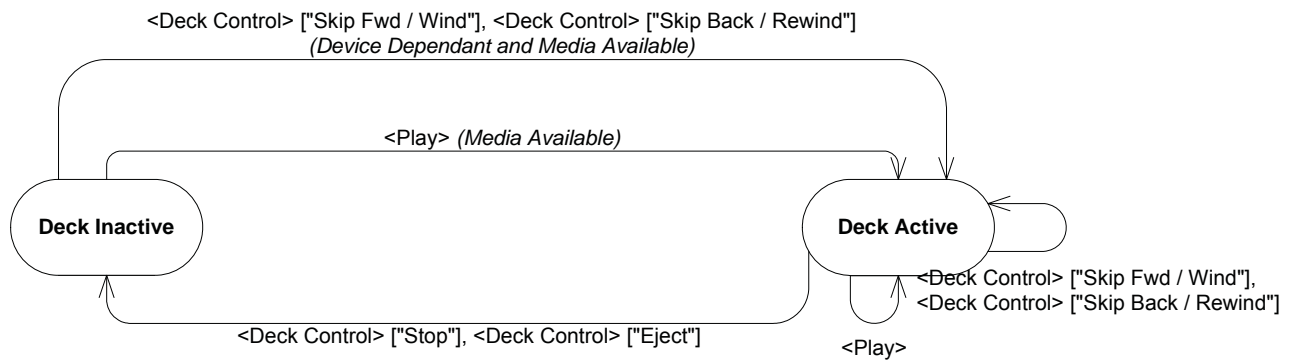

CEC 14.1.7 Menu Providing Device

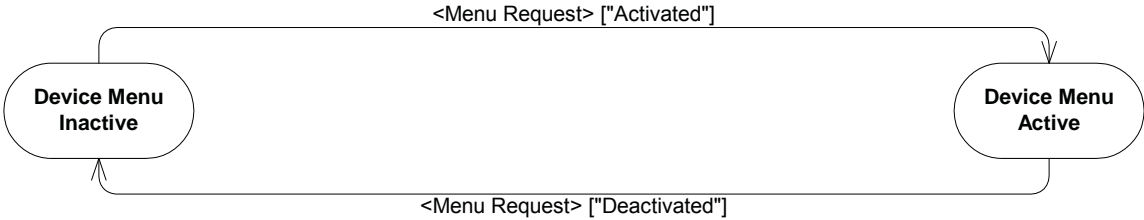

CEC 15 Message Descriptions

The section defines the individual messages used in CEC. It describes them and defines their parameters and expected responses. As CEC has no session layer, this section and the operands section (CEC 17) effectively define the complete messaging system. Tables CEC Table 7 to CEC Table 20 show which messages are mandatory. If a manufacturer implements any of the optional messages, then they shall be implemented as described in CEC 13.

The following list describes each heading within the message tables CEC Table 7 to Table 23.

- **Opcode** – The name used to identify the message.
- **Value** – The unique identifier for the message.
- **Description** – A brief description of the message.
- **Parameters** – The set of parameters used by the message, refer to CEC Table 26 for individual descriptions.
- **Parameter Description** – A brief description of the parameters that the message uses.
- **Response** – Describes how a device should respond on receipt of the message.
- **Directly Addressed** – Indicates if the message may be directly addressed.
- **Broadcast** – Indicates if the message may be broadcast.
- **Mandatory** – Indicates if it is mandatory for a device to react and respond on receipt of the message. Note that where a message is indicated as being mandatory for 'All' devices, this excludes devices which act only as a CEC Switch.

Within the table some cells are intentionally left blank; this indicates that there are no associated requirements for the Opcode described.

CEC Table 7 Message Descriptions for the One Touch Play Feature

Opcode	value	Description	Parameters	Parameter description	Response	Directly addressed	Broadcast	Mandatory for Initiator	Mandatory for Follower
<Active Source> ¹	0x82	Used by a new source to indicate that it has started to transmit a stream OR used in response to a <Request Active Source>	[Physical Address]	The physical address of the device.	A current active source should take appropriate action. TV should switch to the appropriate input. Any CEC switches between source and root shall switch to the appropriate input and come out of standby if necessary.		•	All sources	TV, CEC Switches
<Image View On>	0x04	Sent by a source device to the TV whenever it enters the active state (alternatively it may send <Text View On>).	None		Turn on (if not on). If in 'Text Display' state then the TV enters 'Image Display' state. Note: Should not change TV menu or PIP status.	•		All sources shall implement at least one of <Image View On> or <Text View On>	TV
<Text View On>	0x0D	As <Image View On>, but should also remove any text, menus and PIP windows from the TV's display.	None		As <Image View On>, but should remove PIPs and menus from the screen. The TV enters 'Image Display' state regardless of its previous state.	•		All sources shall implement at least one of <Image View On> or <Text View On>	TV

¹ This message is also used in the Routing Control Feature

CEC Table 8 Message Descriptions for the Routing Control Feature

Opcode	value	Description	Parameters	Parameter description	Response	Directly addressed	Broadcast	Mandatory for Initiator	Mandatory for Follower
<Active Source> ²	0x82	Used by a new source to indicate that it has started to transmit a stream OR used in response to a <Request Active Source>	[Physical Address]	The physical address of the device.	A current active source should take appropriate action. TV should switch to the appropriate input. Any CEC switches between source and root shall switch to the appropriate input and come out of standby if necessary.		•	All sources	TV, CEC Switches
<Inactive Source>	0x9D	Used by the currently active source to inform the TV that it has no video to be presented to the user, or is going into standby as the result of a local user command on the device.	[Physical Address]	The physical address of the device.	The TV may display its own internal tuner and shall send an <Active Source> with the address of the TV; or The TV may send <Set Stream Path> to another device for display.	•			
<Request Active Source>	0x85	Used by a new device to discover the status of the system.	None		<Active Source> from the present active source.		•		All, except for CEC Switches and devices which cannot become a source.

² This message is also used in the One Touch Play Feature

Opcode	value	Description	Parameters	Parameter description	Response	Directly addressed	Broadcast	Mandatory for Initiator	Mandatory for Follower
<Routing Change>	0x80	Sent by a CEC Switch when it is manually switched to inform all other devices on the network that the active route below the switch has changed.	[Original Address] [New Address]	The previous address that the switch was switched to and the new address it has been moved to.	If a CEC Switch is at the new address, it sends a <Routing Information> message to indicate its current active route.		•	CEC Switches and TV (with 2 or more HDMI inputs)	CEC Switches
<Routing Information>	0x81	Sent by a CEC Switch to indicate the active route below the switch.	[Physical Address]	The current active route to the sink in the CEC Switch.	If a CEC Switch is at the specified address it shall send a <Routing Information> message to indicate its current active path.		•	CEC Switches	CEC Switches
<Set Stream Path>	0x86	Used by the TV to request a streaming path from the specified physical address.	[Physical Address]	The physical address of the source device.	Any CEC switches between the TV and the source device shall switch inputs according to the path defined in [Physical Address]. A CEC device at the new address should come out of standby, stream its output and broadcast an <Active Source> message.		•		CEC Switches

CEC Table 9 Message Descriptions for the Standby Feature

Opcode	value	Description	Parameters	Parameter description	Response	Directly addressed	Broadcast	Mandatory for Initiator	Mandatory for Follower
<Standby>	0x36	Switches one or all devices into standby mode. Can be used as a broadcast message or be addressed to a specific device. See section CEC 13.3 for important notes on the use of this message	None		Switch the device into standby. ³ Ignore the message if already in standby.	•	•	TV (Broadcast Address)	All

³ Can be ignored if actively engaged in a recording or providing a source stream for a recording. See also CEC 13.3 for other exceptions.

CEC Table 10 Message Descriptions for the One Touch Record Feature

Opcode	value	Description	Parameters	Parameter description	Response	Directly addressed	Broadcast	Mandatory for Initiator	Mandatory for Follower
<Record Off>	0x0B	Requests a device to stop a recording.	None		Exit 'Recording' state.	•		Device Initiating a recording	Recording Device if implementing <Record On>
<Record On>	0x09	Attempt to record the specified source.	[Record Source]	Source to record, either analogue service, digital service, external source or own source (ie currently selected source).	Enter 'Recording' state and start recording if possible. Send the initiator <Record Status>.	•			
<Record Status>	0x0A	Used by a Recording Device to inform the initiator of the message <Record On> about its status.	[Record Status Info]	The recording status of the device.		•		Recording Device if implementing <Record On>	Device Initiating a recording
<Record TV Screen>	0x0F	Request by the Recording Device to record the presently displayed source.	None		Initiate a recording using the <Record On> message, or send a <Feature Abort> ["Cannot provide source"] if the presently displayed source is not recordable.	•			

CEC Table 11 Message Descriptions for the Timer Programming Feature

Opcode	value	Description	Parameters	Parameter description	Response	Directly addressed	Broadcast	Mandatory for Initiator	Mandatory for Follower
<Clear Analogue Timer>	0x33	Used to clear an Analogue timer block of a device.	See <Set Analogue Timer> message.	See <Set Analogue Timer> message.	Clear timer block if possible, then respond with <Timer Cleared Status>	•			
<Clear Digital Timer>	0x99	Used to clear a Digital timer block of a device.	See <Set Digital Timer> message	See <Set Digital Timer> message	Clear timer block if possible, then respond with <Timer Cleared Status> message.	•			
<Clear External Timer>	0xA1	Used to clear an External timer block of a device.	See <Set External Timer> message	See <Set External Timer> message	Clear timer block if possible, then respond with <Timer Cleared Status> message.	•			
<Set Analogue Timer>	0x34	Used to set a single timer block on an Analogue Recording Device.	[Day of Month] [Month of Year] [Start Time] [Duration] [Recording Sequence] [Analogue Broadcast Type] [Analogue Frequency] [Broadcast System]	A complete set of Analogue timer information for one recording.	<Timer Status> message.	•			
<Set Digital Timer>	0x97	Used to set a single timer block on a Digital Recording Device.	[Day of Month] [Month of Year] [Start Time] [Duration] [Recording Sequence] [Digital Service Identification]	A complete set of Digital timer information for one recording.	<Timer Status> message.	•			

Opcode	value	Description	Parameters	Parameter description	Response	Directly addressed	Broadcast	Mandatory for Initiator	Mandatory for Follower
<Set External Timer>	0xA2	Used to set a single timer block to record from an external device.	[Day of Month] [Month of Year] [Start Time] [Duration] [Recording Sequence] [External Source Specifier] [External Plug] [External Physical Address]	A complete set of External timer information for one recording.	<Timer Status> message.	•			
<Set Timer Program Title>	0x67	Used to set the name of a program associated with a timer block. Sent directly after sending a <Set Analogue Timer> or <Set Digital Timer> message. The name is then associated with that timer block.	[Program Title String]	Program title	Recording device stores title for future reference. Ignore message if it is not the immediate next message from this initiator following a <Set Analogue Timer> or <Set Digital Timer> message.	•			
<Timer Cleared Status>	0x43	Used to give the status of a <Clear Analogue Timer>, <Clear Digital Timer> or <Clear External Timer> message.	[Timer Cleared Status Data]	Indicates if the timer was cleared successfully.	If the message indicates that the timer was not cleared because there was no matching entry, the device should remove the timer block locally.	•			
<Timer Status>	0x35	Used to send timer status to the initiator of a <Set Timer> message.	[Timer Status Data]	Indicates the timer status		•			

CEC Table 12 Message Descriptions for the System Information Feature

Opcode	value	Description	Parameters	Parameter description	Response	Directly addressed	Broadcast	Mandatory for Initiator	Mandatory for Follower
<CEC Version>	0x9E	Used to indicate the supported CEC version, in response to a <Get CEC Version>	[CEC Version]	A value indicating the supported CEC Version		•		4	5
<Get CEC Version>	0x9F	Used by a device to enquire which version of CEC the target supports	None		The source responds with a <CEC Version> message indicating the CEC version	•		6	7
<Give Physical Address>	0x83	A request to a device to return its physical address.	None		<Report Physical Address>	•			All, except for CEC Switches using logical address 15
<Get Menu Language>	0x91	Sent by a device capable of character generation (for OSD and Menus) to a TV in order to discover the currently selected Menu language. Also used by a TV during installation to discover the currently set menu language of other devices.	None		The addressed device responds with a <Set Menu Language> message	•			TV with OSD / Menu generation capabilities

⁴ This message is also used in the Vendor Specific Command Feature - see CEC Table 15 for requirements

⁵ This message is also used in the Vendor Specific Command Feature - see CEC Table 15 for requirements

⁶ This message is also used in the Vendor Specific Command Feature - see CEC Table 15 for requirements

⁷ This message is also used in the Vendor Specific Command Feature - see CEC Table 15 for requirements

Opcode	value	Description	Parameters	Parameter description	Response	Directly addressed	Broadcast	Mandatory for Initiator	Mandatory for Follower
<Polling Message>	-	Used by any device for device discovery – similar to ping in other protocols.	None		Shall set a low level ACK.	•		All except for CEC Switches	All except for CEC switches
<Report Physical Address>	0x84	Used to inform all other devices of the mapping between physical and logical address of the initiator.	[Physical Address] [Device Type]	The device's physical address within the cluster.			•	All	TV
<Set Menu Language>	0x32	Used by a TV or another device to indicate the menu language.	[Language]	The user's menu language choice.	Set the menu language as specified, if possible.		•	TV	All, except for TV, CEC Switches and devices without OSD/ Menu generation capabilities

CEC Table 13 Message Descriptions for the Deck Control Feature

Opcode	value	Description	Parameters	Parameter description	Response	Directly addressed	Broadcast	Mandatory for Initiator	Mandatory for Follower
<Deck Control>	0x42	Used to control a device's media functions.	[Deck Control Mode]	The deck control requested.	Perform the specified actions, or return a <Feature Abort> message. It is device dependent whether or not a Skip Forward/Wind or Skip Backward /Rewind command is legal when in the 'Deck Inactive' state. If the device is in standby and receives an eject command, it should power on and eject its media.	•			
<Deck Status>	0x1B	Used to provide a deck's status to the initiator of the <Give Deck Status> message.	[Deck Info]	Information on the device's current status.		•			
<Give Deck Status>	0x1A	Used to request the status of a device, regardless of whether or not it is the current active source.	[Status Request]	Allows the initiator to request the status once or on all future state changes. Or to cancel a previous <Give Deck Status> ["On"] request.	<Deck Status>	•			
<Play>	0x41	Used to control the playback behaviour of a source device.	[Play Mode]	Play mode required.	Perform the specified actions, or return a <Feature Abort> message. If media is available the device enters 'Deck Active' state. If the device is in standby, has media available and the parameter is ["Play Forward"] it should power on.	•			

CEC Table 14 Message Descriptions for the Tuner Control Feature

Opcode	value	Description	Parameters	Parameter description	Response	Directly addressed	Broadcast	Mandatory for Initiator	Mandatory for Follower
<Give Tuner Device Status>	0x08	Used to request the status of a tuner device.	[Status Request]	Allows the initiator to request the status once or on all future state changes, or to cancel a previous <Give Tuner Device Status> ["On"] message.	Respond with a <Tuner Device Status> message, or stop reporting changes on receipt of the ["Off"] message.	•			
<Select Analogue Service>	0x92	Directly selects an Analogue TV service	[Analogue Broadcast Type] [Analogue Frequency] [Broadcast System]	Defines Broadcast Type, Frequency and System for an Analogue TV service	Change to the selected analogue service and stream its output on the HDMI connection. If the tuner device is not capable of selecting this service, respond with a <Feature Abort>	•			
<Select Digital Service>	0x93	Directly selects a Digital TV, Radio or Data Broadcast Service	[Digital Service Identification]	Defines Digital TV system and necessary data to specify a service	Change to the selected digital service and stream its output on the HDMI connection. If the tuner device is not capable of selecting this service, respond with a <Feature Abort>	•			
<Tuner Device Status>	0x07	Use by a tuner device to provide its status to the initiator of the <Give Tuner Device Status> message.	[Tuner Device Info]	Information on the tuner devices current status.		•			
<Tuner Step Decrement>	0x06	Used to tune to next lowest service in a tuner's service list. Can be used for PIP.	None		Follower tunes to next lowest service in its service list.	•			
<Tuner Step Increment>	0x05	Used to tune to next highest service in a tuner's service list. Can be used for PIP.	None		Follower tunes to next highest service in its service list.	•			

CEC Table 15 Message Descriptions for the Vendor Specific Commands Feature

Opcode	value	Description	Parameters	Parameter description	Response	Directly addressed	Broadcast	Mandatory for Initiator	Mandatory for Follower
<CEC Version> ⁸	0x9E	Used to indicate the supported CEC version, in response to a <Get CEC Version>	[CEC Version]	A value indicating the supported CEC Version		•		All devices that want to be able to use the <Vendor Command> message from specific other vendors.	All devices that want to be able to use the <Vendor Command> message from specific other vendors.
<Device Vendor ID>	0x87	Reports the vendor ID of this device.	[Vendor ID]	The vendor ID of the device.	Any other interested device may store the vendor ID of the device.		•	As needed for Devices supporting Vendor Specific Commands	As needed for Devices supporting Vendor Specific Commands
<Get CEC Version> ⁹	0x9F	Used by a device to enquire which version of CEC the target supports	None		The source responds with a <CEC Version> message indicating the CEC version	•		All devices that want to initiate a scenario with devices of specific other vendors using the <Vendor Command> message.	All devices that want to be able to use the <Vendor Command> message from specific other vendors.

⁸ This message is also used in the System Information Feature

⁹ This message is also used in the System Information Feature

Opcode	value	Description	Parameters	Parameter description	Response	Directly addressed	Broadcast	Mandatory for Initiator	Mandatory for Follower
<Give Device Vendor ID>	0x8C	Requests the Vendor ID from a device.	None		<Device Vendor ID>	•		As needed for Devices which initiate a scenario using the <Vendor Command> message	As needed for Devices supporting Vendor Specific Commands
<Vendor Command>	0x89	Allows vendor specific commands to be sent between two devices.	[Vendor Specific Data]	Vendor specific command or data. The maximum length of the [Vendor Specific Data] in this message shall not exceed 14 data blocks.	Vendor Specific	•			
<Vendor Command With ID>	0xA0	Allows vendor specific commands to be sent between two devices or broadcast.	[Vendor ID] [Vendor Specific data]	Vendor ID of the vendor or entity defining the command. Vendor specific command or data. The maximum length of [Vendor Specific Data] in this message shall not exceed 11 data blocks.	Vendor specific	•	•		
<Vendor Remote Button Down>	0x8A	Indicates that a remote control button has been depressed.	[Vendor Specific RC Code]	The vendor specific Remote Control Code for the key pressed. It is recommended to keep this to a minimum size. The maximum length shall not exceed 14 data blocks to avoid saturating the bus.	Vendor Specific	•	•		

Opcode	value	Description	Parameters	Parameter description	Response	Directly addressed	Broadcast	Mandatory for Initiator	Mandatory for Follower
<Vendor Remote Button Up>	0x8B	Indicates that a remote control button (the last button pressed indicated by the Vendor Remote Button Down message) has been released.	None		Vendor Specific	•	•		

CEC Table 16 Message Descriptions for the OSD Display Feature

Opcode	value	Description	Parameters	Parameter description	Response	Directly addressed	Broadcast	Mandatory for Initiator	Mandatory for Follower
<Set OSD String>	0x64	Used to send a text message to output on a TV.	[Display Control] [OSD String]	Display timing. Text to be displayed.	TV displays the message.	•			

CEC Table 17 Message Descriptions for the Device OSD Transfer Feature

Opcode	value	Description	Parameters	Parameter description	Response	Directly addressed	Broadcast	Mandatory for Initiator	Mandatory for Follower
<Give OSD Name>	0x46	Used to request the preferred OSD name of a device for use in menus associated with that device.	None		<Set OSD Name>	•			
<Set OSD Name>	0x47	Used to set the preferred OSD name of a device for use in menus associated with that device.	[OSD Name]	The preferred name of the device.	Store the name and use it in any menus associated with that device.	•			

CEC Table 18 Message Descriptions for the Device Menu Control Feature

Opcode	value	Description	Parameters	Parameter description	Response	Directly addressed	Broadcast	Mandatory for Initiator	Mandatory for Follower
<Menu Request>	0x8D	A request from the TV for a device to show/remove a menu or to query if a device is currently showing a menu.	[Menu Request Type]	Indicates if the menu request is to activate or deactivate the devices menu, or to simply query the devices menu status.	May enter or exit the 'Device Menu Active' state if the parameter was "Activate" or "Deactivate" Send <Menu Status> to indicate the current status of the devices menu.	•			
<Menu Status>	0x8E	Used to indicate to the TV that the device is showing/has removed a menu and requests the remote control keys to be passed though.	[Menu State]	Indicates if the device is in the 'Device Menu Active' state or 'Device Menu Inactive' state.	If Menu State indicates activated, TV enters 'Device Menu Active' state and forwards those Remote control commands, shown in Table 26, to the initiator. If deactivated, TV enters 'Device Menu Inactive' state and stops forwarding remote control commands.	•			
<User Control Pressed> ¹⁰	0x44	Used to indicate that the user pressed a remote control button or switched from one remote control button to another.	[UI Command]	UI command issued by user.	Update display or perform an action, as required.	•			
<User Control Released> ¹¹	0x45	Indicates that user released a remote control button (the last one indicated by the <User Control Pressed> message)	None		Update display or perform an action, as required.	•			

¹⁰ This message is also used in the RC Passthrough and System Audio Features¹¹ This message is also used in the RC Passthrough and System Audio Features

CEC Table 19 Message Descriptions for the Remote Control Passthrough Feature

Opcode	value	Description	Parameters	Parameter description	Response	Directly addressed	Broadcast	Mandatory for Initiator	Mandatory for Follower
<User Control Pressed> ¹²	0x44	Used to indicate that the user pressed a remote control button or switched from one remote control button to another.	[UI Command]	UI command issued by user.	Update display or perform an action, as required.	•			
<User Control Released> ¹³	0x45	Indicates that user released a remote control button (the last one indicated by the <User Control Pressed> message)	None		Update display or perform an action, as required.	•			

CEC Table 20 Message Descriptions for the Power Status Feature

Opcode	value	Description	Parameters	Parameter description	Response	Directly addressed	Broadcast	Mandatory for Initiator	Mandatory for Follower
<Give Device Power Status>	0x8F	Used to determine the current power status of a target device	None		<Report Power Status>	•			All (except CEC switches)
<Report Power Status>	0x90	Used to inform a requesting device of the current power status	[Power Status]	The current power status		•		All (except CEC switches)	

¹² This message is also used in the Device Menu Control and System Audio Features

¹³ This message is also used in the Device Menu Control and System Audio Features

CEC Table 21 Message Descriptions for General Protocol messages

Opcode	value	Description	Parameters	Parameter description	Response	Directly addressed	Broadcast	Mandatory for Initiator	Mandatory for Follower
<Feature Abort>	0x00	Used as a response to indicate that the device does not support the requested message type, or that it cannot execute it at the present time.	[Feature Opcode] [Abort Reason]	The Opcode of the aborted message. The reason provides an indication as to whether the follower does not support the message, or does support the message but cannot respond at the present time.	Assume that request is not supported or has not been actioned.	•		Generate if a message is not supported	All
<Abort> Message	0xFF	This message is reserved for testing purposes.	None		A device shall never support this message, and shall always respond with a <Feature Abort> message containing any valid value for [Abort Reason]. CEC switches shall not respond to this message.	•			All, except for CEC switches

CEC Table 22 Message Descriptions for the System Audio Control Feature

Opcode	value	Description	Parameters	Parameter description	Response	Directly addressed	Broadcast	Mandatory for Initiator	Mandatory for Follower
<Give Audio Status>	0x71	Requests an amplifier to send its volume and mute status	None		<Report Audio Status>	•			
<Give System Audio Mode Status>	0x7D	Requests the status of the System Audio Mode	None		Amplifier sends a <System Audio Mode Status> message indicating status (On or Off)	•			
<Report Audio Status>	0x7A	Reports an amplifier's volume and mute status	[Audio Status]	Volume and mute status		•			
<Set System Audio Mode>	0x72	Turns the System Audio Mode On or Off.	[System Audio Status]	Specifies if the System Audio Mode is On or Off.	<p>If set to On, the TV mutes its speakers. The TV or STB sends relevant <User Control Pressed> or <User Control Released> as necessary.</p> <p>If set to Off, the TV unmutes its speakers. The TV or STB stop sending the volume-related <User Control Pressed> or <User Control Released> messages.</p>	•	•		

Opcode	value	Description	Parameters	Parameter description	Response	Directly addressed	Broadcast	Mandatory for Initiator	Mandatory for Follower
<System Audio Mode Request>	0x70	A device implementing System Audio Control and which has volume control RC buttons (eg TV or STB) requests to use System Audio Mode to the amplifier	[Physical Address]	Source to be used is the device specified at this address.	<p>The amplifier comes out of standby (if necessary) and switches to the relevant connector for device specified by [Physical Address]. It then sends a <Set System Audio Mode> [On] message.</p> <p><System Audio Mode Request> sent without a [Physical Address] parameter requests termination of the feature. In this case, the amplifier sends a <Set System Audio Mode> [Off] message.</p>	•			
<System Audio Mode Status>	0x7E	Reports the current status of the System Audio Mode	[System Audio Status]	Current system Audio Mode	If [On], the device requesting this information can send the volume-related <User Control Pressed> or <User Control Released> messages.	•			
<User Control Pressed> ¹⁴	0x44	Used to indicate that the user pressed a remote control button or switched from one remote control button to another.	[UI Command] of "Volume Up", "Volume Down" or "Mute"	Relevant UI command issued by user.	Increase or Decrease the volume of the amplifier, or mute/unmute the amplifier.	•			

¹⁴ This message is also used in the Device Menu Control and RC Rassthrough Features

Opcode	value	Description	Parameters	Parameter description	Response	Directly addressed	Broadcast	Mandatory for Initiator	Mandatory for Follower
<User Control Released> ¹⁵	0x45	Indicates that user released a remote control button (the last one indicated by the <User Control Pressed> message)	None		Stop increasing or decreasing the volume	•			

CEC Table 23 Message Descriptions for the Audio Rate Control Feature

Opcode	value	Description	Parameters	Parameter description	Response	Directly addressed	Broadcast	Mandatory for Initiator	Mandatory for Follower
<Set Audio Rate>	0x9A	Used to control audio rate from Source Device.	[Audio Rate]	The audio rate requested.	Perform the specified actions, or return a<Feature Abort> message.	•			

¹⁵ This message is also used in the Device Menu Control and RC Rassthrough Features

CEC 16 Message Dependencies

This section describes the dependencies between each message. This section is divided into two tables, which describe the following:

- CEC Table 24 describes the message dependencies when a device is capable of receiving a particular message (i.e. it does not <Feature Abort> indicating an [“Unrecognized opcode”] in response to the message).
- CEC Table 25 describes the message dependencies when a device is capable of sending a particular message.
- Each table describes the additional messages that the device shall be capable of receiving and sending if a particular message is supported.

CEC Table 24 Message dependencies when receiving a message

If device does not <Feature Abort> the following message:	It shall not <Feature Abort> the message(s):	It shall be able to send the message(s):
<CEC Version>	-	<Get CEC Version>
<Clear Analogue Timer>	<Set Analogue Timer>; and <Clear External Timer>, <Set External Timer> if Recording Device supports external recording	<Timer Status>, <Timer Cleared Status>;
<Clear Digital Timer>	<Set Digital Timer>; and <Clear External Timer>, <Set External Timer> if Recording Device supports external recording	<Timer Status>, <Timer Cleared Status>;
<Clear External Timer>	<Set External Timer>;	<Timer Status>, <Timer Cleared Status>;
<Deck Control>	<Play>	<Deck Status>
<Deck Status>	-	<Play>, <Deck Control>
<Device Vendor ID> ¹⁶		<Give Device Vendor ID>
<Get CEC Version>	-	<CEC Version>
<Get Menu Language>	-	<Set Menu Language>
<Give Audio Status>	-	<Report Audio Status>

¹⁶ This message is broadcast and there is therefore no <Feature Abort>, but devices accepting this message shall also be able to send the associated message

If device does not <Feature Abort> the following message:	It shall not <Feature Abort> the message(s):	It shall be able to send the message(s):
<Give Deck Status>	<Play>, <Deck Control>	<Deck Status>
<Give Device Power Status>	-	<Report Power Status>
<Give Device Vendor ID>	-	<Device Vendor ID>
<Give OSD Name>	-	<Set OSD Name>
<Give Physical Address>	-	<Report Physical Address>
<Give System Audio Status>	<System Audio Mode Request>, <User Control Pressed>[Volume Up Down Mute], <User Control Released>	<Set System Audio Mode>, <System Audio Mode Status>
<Give Tuner Device Status>		<Tuner Device Status>
<Image View On>	<Active Source> ¹⁷	-
<Inactive Source>	-	<Active Source>, <Set Stream Path>
<Menu Request>	<User Control Pressed>, <User Control Released>	<Menu Status>
<Menu Status>	-	<User Control Pressed>, <User Control Released>
<Play>	<Deck Control>	<Deck Status>
<Record Off>	<Record On>	<Record Status>
<Record On>	<Record Off>	<Record Status>
<Record Status>	-	<Record On>, <Record Off>
<Record TV Screen>	<Record Status>	<Record On>, <Record Off>
<Request Active Source> ¹⁸	-	<Active Source>
<Routing Change> ¹⁹	<Routing Information>	-

¹⁷ This message is broadcast and there is therefore no <Feature Abort>, but devices shall also accept the associated message.

¹⁸ This message is broadcast and there is therefore no <Feature Abort>, but devices accepting this message shall also be able to send the associated message.

¹⁹ This message is broadcast and there is therefore no <Feature Abort>, but devices shall also accept the associated message.

If device does not <Feature Abort> the following message:	It shall not <Feature Abort> the message(s):	It shall be able to send the message(s):
<Routing Information> ²⁰	<Routing Change>	-
<Set Analogue Timer>	<Clear Analogue Timer>; and <Clear External Timer> and <Set External Timer> if device supports external recording	<Timer Status>, <Timer Cleared Status>
<Set Audio Rate>	-	-
<Set Digital Timer>	<Clear Digital Timer>; and <Clear External Timer> and <Set External Timer> if device supports external recording	<Timer Status>, <Timer Cleared Status>
<Set External Timer>	<Clear External Timer>;	<Timer Status>, <Timer Cleared Status>
<Set System Audio Mode>	<System Audio Mode Status>	<System Audio Mode Request> <User Control Pressed>[Volume Up Down Mute], <User Control Released>
<Set Menu Language>	-	-
<Set OSD Name>	-	<Give OSD Name>
<Set OSD String>	-	-
<Set Stream Path> ²¹	-	<Active Source> (not CEC Switches)
<System Audio Status>	<Set System Audio Mode>	<System Audio Mode Request>, <User Control Pressed>[Volume Up Down Mute], <User Control Released>
<System Audio Mode Request>	<Give System Audio Mode Status>, <User Control Pressed>[Volume Up Down Mute], <User Control Released>	<Set System Audio Mode>, <System Audio Mode Status>
<Text View On>	<Active Source>	-
<Timer Cleared Status>	<Timer Status>	

²⁰ This message is broadcast and there is therefore no <Feature Abort>, but devices shall also accept the associated message.

²¹ This message is broadcast and there is therefore no <Feature Abort>, but devices accepting this message shall also be able to send the associated message.

If device does not <Feature Abort> the following message:	It shall not <Feature Abort> the message(s):	It shall be able to send the message(s):
<Tuner Device Status>	-	<Give Tuner Device Status>
<Timer Status>	<Timer Cleared Status>	
<Tuner Step Decrement>	<Tuner Step Increment>	-
<Tuner Step Increment>	<Tuner Step Decrement>	-
<User Control Pressed>	<User Control Released>	-
<User Control Released>	<User Control Pressed>	-
<Vendor Command>	<Device Vendor ID>	<Give Device Vendor ID>
<Vendor Command With ID> ²²	<Device Vendor ID>	<Give Device Vendor ID>
<Vendor Remote Button Down> ²³	<Vendor Remote Button Up>, <Device Vendor ID>	<Give Device Vendor ID>
<Vendor Remote Button Up> ²⁴	<Vendor Remote Button Down>, <Device Vendor ID>	<Give Device Vendor ID>

²² This message can be broadcast and there may not be a <Feature Abort>, but devices shall also accept the associated messages and also be able to send the associated message.

²³ This message can be broadcast and there may not be a <Feature Abort>, but devices shall also accept the associated messages and also be able to send the associated message.

²⁴ This message can be broadcast and there may not be a <Feature Abort>, but devices shall also accept the associated messages and also be able to send the associated message.

CEC Table 25 Message dependencies when sending a message

If device ever sends the following message:	It shall be able to send the message(s):	It shall not <Feature Abort> the message(s):
<CEC Version>	-	<Get CEC Version>
<Clear Analogue Timer>	<Set Analogue Timer>; and <Set External Timer>, <Clear External Timer> if Recording Device supports External recording	<Timer Cleared Status>, <Timer Status>
<Clear Digital Timer>	<Set Digital Timer>; and <Set External Timer>, <Clear External Timer> if Recording Device supports External recording	<Timer Cleared Status>, <Timer Status>
<Clear External Timer>	<Set External Timer>	<Timer Cleared Status>, <Timer Status>
<Deck Control>	<Play>	-
<Deck Status>	-	<Give Deck Status>, <Play>, <Deck Control>
<Device Vendor ID>	-	<Give Device Vendor ID>
<Get CEC Version>	-	<CEC Version>
<Get Menu Language>	-	<Set Menu Language> ²⁵
<Give Deck Status>	<Play>, <Deck Control>	<Deck Status>
<Give Device Vendor ID>	-	<Device Vendor ID> ²⁶
<Give OSD Name>	-	<Set OSD Name>
<Give Physical Address>	-	<Report Physical Address> ²⁷
<Give Tuner Device Status>	-	<Tuner Device Status>

²⁵ This message is broadcast and there is therefore no <Feature Abort>, but devices sending the associated message shall also be able to send this message.

²⁶ This message is broadcast and there is therefore no <Feature Abort>, but devices sending the associated message shall also be able to send this message.

²⁷ This message is broadcast and there is therefore no <Feature Abort>, but devices sending the associated message shall also be able to send this message.

If device ever sends the following message:	It shall be able to send the message(s):	It shall not <Feature Abort> the message(s):
<Image View On>	<Active Source>	-
<Inactive Source>	-	<Active Source>, <Set Stream Path>
<Menu Request>	<User Control Pressed>, <User Control Released>	<Menu Status>
<Menu Status>	-	<Menu Request>, <User Control Pressed>, <User Control Released>
<Play>	<Deck Control>	-
<Record Off>	<Record On>	<Record Status>
<Record On>	<Record Off>	<Record Status>
<Record Status>	-	<Record On>, <Record Off>
<Record TV Screen>	<Record Status>	<Record On>, <Record Off>
<Report Audio Status>	-	<Give Audio Status>
<Report Power Status>	-	<Give Device Power Status>
<Request Active Source>	-	<Active Source> ²⁸
<Routing Change>	<Routing Information>	-
<Routing Information>	<Routing Change>	-
<Set Analogue Timer>	<Clear Analogue Timer>; and <Set Digital Timer>, <Clear Digital Timer> if TV or STB has a Digital Tuner; and <Clear External Timer>, <Set External Timer>	<Timer Status>, <Timer Cleared Status>
<Set Audio Rate>	-	-

²⁸ This message is broadcast and there is therefore no <Feature Abort>, but devices sending the associated message shall also be able to send this message.

If device ever sends the following message:	It shall be able to send the message(s):	It shall not <Feature Abort> the message(s):
<Set Digital Timer>	<Clear Digital Timer>; and <Set Analogue Timer>, <Clear Analogue Timer> if TV or STB has an Analogue Tuner; and <Clear External Timer>, <Set External Timer>	<Timer Status>, <Timer Cleared Status>
<Set External Timer>	<Clear External Timer>; and <Set Analogue Timer>, <Clear Analogue Timer> if TV or STB has an Analogue Tuner; and <Set Digital Timer>, <Clear Digital Timer> if TV or STB has a Digital Tuner	<Timer Status>, <Timer Cleared Status>
<Set System Audio Mode>	<System Audio Mode Status>	<Give System Audio Mode Status>, <User Control Pressed>[Volume Up Down Mute], <User Control Released>
<Set Menu Language>	-	<Get Menu Language>
<Set OSD Name>	-	<Give OSD Name>
<Set Stream Path>	-	<Active Source> (not CEC Switches)
<System Audio Mode Status>	<Set System Audio Mode>	<Give System Audio Mode Status>, <System Audio Mode Request>, <User Control Pressed>[Volume Up Down Mute], <User Control Released>
<System Audio Mode Request>	<User Control Pressed>[Volume Up Down Mute], <User Control Released>	<System Audio Mode Status>, <Set System Audio Mode>
<Text View On>	<Active Source>	-
<Timer Cleared Status>	<Timer Status>	<Clear Analogue Timer>, <Clear Digital Timer>, <Clear External Timer>
<Timer Status>	<Timer Cleared Status>	<Set Analogue Timer>, <Set Digital Timer>, <Set External Timer>
<Tuner Device Status>	-	<Give Tuner Device Status>
<Tuner Step Decrement>	<Tuner Step Increment>	-

If device ever sends the following message:	It shall be able to send the message(s):	It shall not <Feature Abort> the message(s):
<Tuner Step Increment>	<Tuner Step Decrement>	-
<User Control Released>	<User Control Pressed>	-
<Vendor Command>	<Device Vendor ID>	<Give Device Vendor ID>
<Vendor Command With ID>	<Device Vendor ID>	<Give Device Vendor ID>
<Vendor Remote Button Down>	<Vendor Remote Button Up>, <Device Vendor ID>	<Give Device Vendor ID>
<Vendor Remote Button Up>	<Vendor Remote Button Down>, <Device Vendor ID>	<Give Device Vendor ID>

CEC 17 Operand Descriptions

In the following table, Operand Descriptions are ordered alphabetically. Sub-operands, which only occur in a single parent operand, are grouped with their parent and are shown indented.

Not all operand values are shown in the table: these shall be considered as “reserved”.

CEC Table 26 Operand Descriptions.

Name	Range Description		Length	Purpose
[Abort Reason]	“Unrecognized opcode”	0	1 byte	Reason for a <Feature Abort> response.
	“Not in correct mode to respond”	1		
	“Cannot provide source”	2		
	“Invalid operand”	3		
	“Refused”	4		
[Analogue Broadcast Type]	“Cable”	0x00	1 byte	Indicates the Analogue broadcast type
	“Satellite”	0x01		
	“Terrestrial”	0x02		
[Analogue Frequency]	0x0000<N<0xFFFF Frequency = 62.5n kHz		2 bytes	Used to specify the frequency used by an analogue tuner.
[ASCII digit]	0x30≤N≤0x39		1 byte	Subset of [ASCII] representing a printable digit character.
[ASCII]	0x20≤N≤0x7E		1 byte	Represents a printable character.
[Audio Rate]	“Rate Control Off”	0	1 byte	Control Off Wide Range Control (IEEE 1394 compatible)
	“Standard Rate”: 100% rate	1		
	“Fast Rate”: Max 101% rate	2		
	“Slow Rate”: Min 99% rate	3		

Name		Range Description		Length	Purpose	
		"Standard Rate": 100.0% rate	4		Narrow Range Control (HDMI Transparent)	
		"Fast Rate": Max 100.1% rate	5			
		"Slow Rate": Min 99.9% rate	6			
[Audio Status]		[Audio Mute Status]	Bit 7	1 bit	Used to indicate the current audio status of a device.	
		[Audio Volume Status]	Bits 6-0	7 bits		
	[Audio Mute Status]	"Audio Mute Off"	0	1 bit	Used to indicate the current audio mute status of a device.	
			"Audio Mute On"			1
	[Audio Volume Status]		0x00≤N≤0x64		7 bits	Used to indicate the current audio volume status of a device. N indicates audio playback volume, expressed as a percentage (0% - 100%). N=0 is no sound; N=100 is maximum volume sound level. The linearity of the sound level is device dependent. This value is mainly used for displaying a volume status bar on a TV screen.
			0x65≤N≤0x7E			
		0x7F		Current audio volume status is unknown		
[Boolean]		"False"	0	1 byte	Flag	
		"True"	1			
[Broadcast System]		0≤N≤31 – See CEC Table 28		1 byte	This specifies information about the color system, the sound carrier and the IF-frequency	

Name		Range Description		Length	Purpose	
[CEC Version]		"Version 1.1"	0x00	1 byte	Indicates the supported CEC version	
		"Version 1.2"	0x01			
		"Version 1.2a"	0x02			
		"Version 1.3"	0x03			
		"Version 1.3a"	0x04			
[Channel Identifier]		[Channel Number Format] [Major Channel Number] [Minor Channel Number]		4 bytes	Identifies a 1-part Logical or Virtual Channel Number or a 2-part Major and Minor channel combination	
	[Channel Number Format]		"1-part Channel Number"	0x01	6 bits	Identifies Channel Format
			"2-part Channel Number"	0x02		
	[Major Channel Number]		If [Channel Number Format] is "2-part Channel Number", this operand represents a 3-digit Major channel number in hexadecimal format; if [Channel Number Format] is "1-part Channel Number" this operand shall be ignored.		10 bits	Major Channel Number (if Channel Number Format is 2-part)
[Minor Channel Number]		If [Channel Number Format] is "1-part Channel Number" this operand represents a 1-part Channel Number in hexadecimal format; If [Channel Number Format] is "2-part Channel Number", this operand represents a Minor channel number in hexadecimal format		16 bits	1-part Channel Number, or a Minor Channel Number (if Channel Number Format is 2-part)	
[Day of Month]		1≤N≤31		1 byte	Day of month.	

Name	Range Description		Length	Purpose
[Deck Control Mode]	"Skip Forward / Wind"	1	1 byte	Used in <Deck Control>. Note: The "Skip Forward / Wind" and "Skip Reverse / Rewind" values are used for example in a DVD as next chapter and previous chapter and in a VCR as wind and rewind.
	"Skip Reverse / Rewind"	2		
	"Stop"	3		
	"Eject"	4		
[Deck Info]	"Play"	0x11	1 byte	Indicates the current status of a tape or disk deck.
	"Record"	0x12		
	"Play Reverse"	0x13		
	"Still"	0x14		
	"Slow"	0x15		
	"Slow Reverse"	0x16		
	"Fast Forward"	0x17		
	"Fast Reverse"	0x18		
	"No Media"	0x19		
	"Stop"	0x1A		
	"Skip Forward / Wind"	0x1B		
	"Skip Reverse / Rewind"	0x1C		
	"Index Search Forward"	0x1D		
	"Index Search Reverse"	0x1E		
"Other Status"	0x1F			

Name		Range Description		Length	Purpose	
[Device Type]		“TV”	0	1 byte	Allows additional devices, above the number allowed in the logical addressing mechanism, to indicate their device type	
		“Recording Device”	1			
		Reserved	2			
		“Tuner”	3			
		“Playback Device”	4			
		“Audio System”	5			
[Digital Service Identification]		[Service Identification Method] [Digital Broadcast System] [Service Identification]		7 bytes	Indicates Digital Broadcast System and the parameters to identify a specific service.	
	[Service Identification Method]	“Service identified by Digital IDs”	0	1 bit	Indicates that a service is identified by digital service IDs	
		“Service identified by Channel”	1		Indicates that a service is identified by a logical or virtual channel number	
	[Digital Broadcast System]			7 bits	Indicates the Digital Broadcast System of required service. This is present irrespective of the state of [Service Identification Method]	
		“ARIB generic”			0x00	Generic formats ²⁹
		“ATSC generic”			0x01	
		“DVB generic”			0x02	
		“ARIB”	“ARIB-BS”		0x08	Specific Formats
			“ARIB-CS”		0x09	
			“ARIB-T”		0x0A	
		“ATSC”	“Cable”		0x10	

²⁹ These formats are included for legacy devices. New devices shall use the Specific Formats starting at 0x08

Name		Range Description			Length	Purpose
			"Satellite"	0x11		
			"Terrestrial"	0x12		
		"DVB"	"DVB-C"	0x18		
			"DVB-S"	0x19		
			"DVB S2"	0x1A		
			"DVB-T"	0x1B		
	[Service Identification]	[ARIB data]			6 bytes	Specifies an ARIB digital service
		[ATSC data]				Specifies an ATSC digital service
		[DVB data]				Specifies a DVB digital service
		[Channel data]				When [Service Identification Method] is "Service identified by Channel", this indicates the channel number
	[ARIB data]	"Transport_stream_ID"			2 bytes	The transport_stream_ID of the transport stream carrying the required service
		"Service_ID"			2 bytes	The service_ID of the required service
		"Original_Network_ID"			2 bytes	The original_network_ID of the network carrying the transport stream for the required service
	[ATSC data]	"Transport_stream_ID"			2 bytes	The transport_stream_ID of the transport stream carrying the required service
		"Program_number"			2 bytes	The Program_number of the required service
		"Reserved (0x0000)"			2 bytes	Reserved
	[DVB data]	"Transport_stream_ID"			2 bytes	The transport_stream_ID of the transport stream carrying the required service
		"Service_ID"			2 bytes	The service_ID of the required service

Name		Range Description		Length	Purpose																
		"Original_Network_ID"		2 bytes	The original_network_ID of the network carrying the transport stream for the required service																
	[Channel data]	[Channel Identifier] [Reserved 2 bytes]		6 bytes	Identifies the logical or virtual channel number of a service. See [Channel Identifier] for details.																
[Display Control]	bit 5 – bit 0 = 0			1 byte	To indicate the display mode for an on screen display message.																
			Bit 7 Bit 6																		
	"Display for default time"	0	0																		
	"Display until cleared"	0	1																		
	"Clear previous message"	1	0																		
	Reserved for future use	1	1																		
[Duration]		[Duration Hours] [Minute]		2 bytes																	
	[Duration Hours]	0 ≤ N ≤ 99		1 byte	Duration hours in BCD format: <table border="1" style="margin-left: auto; margin-right: auto;"> <tr> <td colspan="4">MS Byte</td> <td colspan="4">LS Byte</td> </tr> <tr> <td>b3</td><td>b2</td><td>b1</td><td>b0</td> <td>b3</td><td>b2</td><td>b1</td><td>b0</td> </tr> </table>	MS Byte				LS Byte				b3	b2	b1	b0	b3	b2	b1	b0
MS Byte				LS Byte																	
b3	b2	b1	b0	b3	b2	b1	b0														
[External Physical Address]		[Physical Address]		2 bytes	Physical Address of device that is to be used as the source of a recording. See CEC 13.5.3 for information on external connections.																
[External Plug]		Plug number, 1 ≤ N ≤ 255		1 byte	External Plug number on the Recording Device. See CEC 13.5.3 for information on external connections.																
[External Source Specifier]	"External Plug"		4	1 byte	Indicates if External source is specified by the External plug number on the Recording Device, or by the External Physical Address of the required source																
	"External Physical Address"		5																		

Name	Range Description	Length	Purpose																
[Hour]	$0 \leq N \leq 23$	1 byte	Hour in BCD format: <table border="1" data-bbox="1409 310 1974 431" style="margin-left: auto; margin-right: auto;"> <thead> <tr> <th colspan="4">MS Byte</th> <th colspan="4">LS Byte</th> </tr> </thead> <tbody> <tr> <td>b3</td><td>b2</td><td>b1</td><td>b0</td> <td>b3</td><td>b2</td><td>b1</td><td>b0</td> </tr> </tbody> </table>	MS Byte				LS Byte				b3	b2	b1	b0	b3	b2	b1	b0
MS Byte				LS Byte															
b3	b2	b1	b0	b3	b2	b1	b0												
[Feature Opcode]	$0x00 \leq N \leq 0xFF$ (n is defined in CEC Table 7 to CEC Table 23)	1 byte	Defines command to be performed.																
[Language]	3 {[ASCII]} as defined in ISO/FDIS 639-2 [ref 1n]	3 bytes	Specify the language with which to interact with the user.																
[Menu Request Type]	"Activate"	0	Specifies whether to activate or deactivate a devices menu or simply query its current menu status.																
	"Deactivate"	1																	
	"Query"	2																	
[Menu State]	"Activated"	0	Specifies the state of a device menu																
	"Deactivated"	1																	
[Minute]	$0 \leq N \leq 59$	1 byte	Minute in BCD format: <table border="1" data-bbox="1409 972 1974 1089" style="margin-left: auto; margin-right: auto;"> <thead> <tr> <th colspan="4">MS Byte</th> <th colspan="4">LS Byte</th> </tr> </thead> <tbody> <tr> <td>b3</td><td>b2</td><td>b1</td><td>b0</td> <td>b3</td><td>b2</td><td>b1</td><td>b0</td> </tr> </tbody> </table>	MS Byte				LS Byte				b3	b2	b1	b0	b3	b2	b1	b0
MS Byte				LS Byte															
b3	b2	b1	b0	b3	b2	b1	b0												
[Month of Year]	$1 \leq N \leq 12$	1 byte	Month																
[New Address]	[Physical Address]	2 bytes	The physical address of the new device selected by a CEC Switch.																
[Original Address]	[Physical Address]	2 bytes	The physical address of the device de-selected by a CEC Switch.																
[OSD Name]	N {[ASCII]}, $1 \leq N \leq 14$	1 - 14 bytes	The device's name - to be used in On Screen Display references to it.																

Name	Range Description	Length	Purpose
[OSD String]	N {[ASCII]}, 1≤N ≤ 13	1 - 13 bytes	A string to be displayed on the display.
[Physical Address]	4{[Port ID]}	2 bytes	Defines the path between the TV and a device – thus giving it a physical address within the cluster.
	[Port ID]	0x0≤n≤0xF	4 bits Defines one 'hop' within the physical address relating to the physical connection of the device.
[Play Mode]	"Play Forward"	0x24	1 byte The mode in which to play media. Note: If a device does not support a particular play mode it should select the closest match.
	"Play Reverse"	0x20	
	"Play Still"	0x25	
	"Fast Forward Min Speed"	0x05	
	"Fast Forward Medium Speed"	0x06	
	"Fast Forward Max Speed"	0x07	
	"Fast Reverse Min Speed"	0x09	
	"Fast Reverse Medium Speed"	0x0A	
	"Fast Reverse Max Speed"	0x0B	
	"Slow Forward Min Speed"	0x15	
	"Slow Forward Medium Speed"	0x16	
	"Slow Forward Max Speed"	0x17	
	"Slow Reverse Min Speed"	0x19	
	"Slow Reverse Medium Speed"	0x1A	
"Slow Reverse Max Speed"	0x1B		

Name	Range Description		Length	Purpose	
[Power Status]	"On"	0x00	1 byte	Used to indicate the current power status of a device.	
	"Standby"	0x01			
	"In transition Standby to On"	0x02			
	"In transition On to Standby"	0x03			
[Program Title String]	N {[ASCII]}, 1 ≤ N ≤ 14		1 - 14 bytes	Program title.	
[Record Source]	{[Record Source Type]} {[Record Source Type] [Digital Service Identification]} {[Record Source Type] [Analogue Broadcast Type] [Analogue Frequency] [Broadcast System]} {[Record Source Type] [External Plug]} {[Record Source Type] [External Physical Address]}		1 to 8 bytes (depends on source)	To define the source for a recording.	
	[Record Source Type]	"Own source"	1	1 byte	Allows the record source to be specified for a recording.
		"Digital Service"	2		
		"Analogue Service"	3		
		"External Plug"	4		
		"External Physical Address"	5		
[Record Status Info]	"Recording currently selected source"	0x01	1 byte	Indicates the status of a recording.	
	"Recording Digital Service"	0x02			
	"Recording Analogue Service"	0x03			
	"Recording External input"	0x04			

Name	Range Description		Length	Purpose
	"No recording – unable to record Digital Service "	0x05		No suitable tuner.
	"No recording – unable to record Analogue Service"	0x06		No suitable tuner.
	"No recording – unable to select required service"	0x07		Has suitable tuner, but the requested parameters are invalid or out of range for that tuner.
	"No recording – invalid External plug number"	0x09		
	"No recording – invalid External Physical Address"	0x0A		
	"No recording – CA system not supported"	0x0B		
	"No Recording – No or Insufficient CA Entitlements"	0x0C		
	"No recording – Not allowed to copy source"	0x0D		
	"No recording – No further copies allowed"	0x0E		
	"No recording – no media"	0x10		
	"No recording – playing"	0x11		
	"No recording – already recording"	0x12		
	"No recording – media protected"	0x13		
	"No recording – no source signal"	0x14		
	"No recording – media problem"	0x15		

Name	Range Description		Length	Purpose
	"No recording – not enough space available"	0x16		
	"No recording – Parental Lock On"	0x17		
	"Recording terminated normally"	0x1A		Can optionally be sent in response to a <Record Off> message.
	"Recording has already terminated"	0x1B		Can optionally be sent in response to a <Record Off> message.
	"No recording – other reason"	0x1F		
[Recording Sequence]		b6.....b0	8 bits	<p>Indicates if recording is repeated and, if so, on which days.</p> <p>For repeated recordings, the recording sequence value is the bitwise OR of the days when recordings are required.</p> <p>[Recording Sequence] shall be set to 0x00 when the recording is not repeated.</p> <p>Bit 7 is reserved and shall be set to zero.</p>
"Sunday"	0b0000001			
"Monday"	0b0000010			
"Tuesday"	0b0000100			
"Wednesday"	0b0001000			
"Thursday"	0b0010000			
"Friday"	0b0100000			
"Saturday"	0b1000000			
"Once only"	0b0000000			
Bit 7, reserved	0			
[Reserved Bit]	0		1 bit	Used as padding bit for future extensions.

Name		Range Description		Length	Purpose
[Status Request]		“On”	1	1 byte	Contains the status request mode which can be report once or on all future state changes or reporting off.
		“Off”	2		
		“Once”	3		
[Start Time]		[Time]		2 bytes	Indicates the start time for a timer based recording.
[System Audio Status]		“Off”	0	1 byte	Specifies if the System Audio Mode is On or Off
		“On”	1		
[Time]		[Hour][Minute]		2 bytes	Time of day
[Timer Cleared Status Data]		“Timer not cleared – recording”	0x00	1 byte	Indicates status in a <Timer Cleared Status> message.
		“Timer not cleared – no matching”	0x01		
		“Timer not cleared – no info available”	0x02		
		“Timer cleared”	0x80		
[Timer Status Data]		[Timer overlap warning] [Media Info] [Timer Programmed Info]		1 byte or 3 bytes	Used by a recoding device to respond to the initiator of a <Set Timer> message.
	[Timer Overlap Warning]	“No overlap”	0	1 bit	Indicates if there is another timer block already set which overlaps with this new recording request.
		”Timer blocks overlap”	1		
	[Media Info]	“Media present and not protected”	0b00	2 bits	Indicates if removable media is present and its write protect state.
		“Media present, but protected”	0b01		
		“Media not present”	0b10		
		Future Use	0b11		

Name		Range Description		Length	Purpose
	[Timer Programmed Info]	{[Programmed Indicator]} {[Programmed Info] [Duration Available]} {[Not Programmed Error Info] [Duration Available]}		5 bits or 21 bits	Gives information about how and if the programming request has been done. [Programmed Indicator] is used as a selector for the second parameter. [Duration Available] can be optionally returned when: - [Programmed Info] is "Not enough space available" or "May not be enough space available"; or - [Not Programmed Info] is "Duplicate: already programmed" Note that the length depends on whether [Duration Available] is appended
	[Programmed Indicator]	"Not programmed"	0	1 bit	Selector for [Timer Programmed Info].
		"Programmed"	1		
	[Programmed Info]	Future Use	0b0xxx	4 bits	Information indicating any non-fatal issues with the programming request.
		"Enough space available for recording"	0b1000		
		"Not enough space available for recording"	0b1001		
		"May not be enough space available"	0b1011		
		"No Media info available"	0b1010		
	[Not Programmed Error Info]	Future Use	0b0000	4 bits	Reason for programming failure.
		"No free timer available"	0b0001		
		"Date out of range"	0b0010		
		"Recording Sequence error"	0b0011		Recording device does not support this recording sequence, or invalid data
"Invalid External Plug Number"		0b0100			

Name		Range Description		Length	Purpose	
		"Invalid External Physical Address"	0b0101			
		"CA system not supported"	0b0110			
		"No or insufficient CA Entitlements"	0b0111			No or insufficient CA entitlements
		"Does not support resolution"	0b1000			Tuner does not support HD or recorder does not support HD
		"Parental Lock on"	0b1001			
		"Clock Failure"	0b1010			
		Reserved for Future Use	0b1011 to 0b1101			
		"Duplicate: already programmed"	0b1110			A timer block with identical details (of time and service) has already been programmed
[Duration Available]	[Duration]	2 bytes	Optional parameter: Contains an estimate of the space left on the media, expressed as a time. This parameter may be returned when: - [Programmed Info] is "Not enough space available"; or - [Not Programmed Info] is "Duplicate: already programmed"			
[Tuner Device Info]	[Recording Flag][Tuner Display Info] {[Analogue Broadcast Type] [Analogue Frequency][Broadcast System]} [Digital Service Identification]	5 bytes (analogue service); 8 bytes (digital service)	Indicates information about the tuner. Indicates the analogue or digital service that the tuner is set to, regardless of whether or not it is currently displaying the tuner. [Tuner Display Info] also indicates the data in the following bytes.			
[Recording Flag]	"Not being used for recording"	0	1 bit	Indicates if the tuner is being used as a source of a recording		
	"Being used for recording"	1				

Name		Range Description		Length	Purpose
	[Tuner Display Info]	"Displaying Digital Tuner"	0	7 bits	Indicates if the device is currently displaying its tuner or not (it may for example be displaying an external source or media).
		"Not displaying Tuner"	1		
		"Displaying Analogue tuner"	2		
[UI Command]		0x00≤n≤0xFF (n is defined in Table 27)		1 byte	Indicates the remote control button pressed. Note that some [UI Command] messages also have further operands following – see Table 6.
[UI Function Media]		Media number 1 ≤ N ≤ 255 N=0: Media number = current Media number + 1. If current Media number = maximum number in a device, then Media number =1.		1 byte	Number of the Media
[UI Function Select A/V input]		A/V input number 1 ≤ N ≤ 255 N=0: A/V input number = current A/V input number + 1. If current A/V input number = maximum number in a device, then A/V input number =1.		1 byte	Number of the A/V input
[UI Function Select Audio input]		Audio input number 1 ≤ N ≤ 255 N=0: Audio input number = current Audio input number + 1. If current Audio input number = maximum number in a device, then Audio input number = 1.		1 byte	Number of the Audio input
[Vendor ID]		0x000000≤N≤0xFFFFFFFF (n is the 24-bit unique company ID [ref. 3i] obtained from the IEEE Registration Authority Committee (RAC)).		3 bytes	Identifier for a specific Vendor.
[Vendor Specific Data]		Vendor specific command or data, as defined by the manufacturer.		≤14 bytes	The maximum length shall not exceed 14 data blocks to avoid saturating the bus.
[Vendor Specific RC Code]		Remote Control code, as defined by the manufacturer		≤14 bytes	It is recommended to keep this as small as possible to improve speed of response, as seen by the user. The maximum length shall not exceed 14 data blocks.

Notes: Items are transmitted in the order shown in the description.
All bit descriptions are sent most significant bit first (i.e. first bit described is sent first)

CEC Table 27 User Control Codes

Operation id	User Operation
0x00	Select
0x01	Up
0x02	Down
0x03	Left
0x04	Right
0x05	Right-Up
0x06	Right-Down
0x07	Left-Up
0x08	Left-Down
0x09	Root Menu – see Note 2
0x0A	Setup Menu
0x0B	Contents Menu
0x0C	Favorite Menu
0x0D	Exit
0x0E - 0x1F	Reserved
0x20 - 0x29	Numbers 0-9
0x2A	Dot
0x2B	Enter
0x2C	Clear
0x2D - 0x2E	Reserved
0x2F	Next Favorite
0x30	Channel Up
0x31	Channel Down
0x32	Previous Channel
0x33	Sound Select
0x34	Input Select

Operation id	User Operation
0x35	Display Information
0x36	Help
0x37	Page Up
0x38	Page Down
0x39 - 0x3F	Reserved
0x40	Power
0x41	Volume Up
0x42	Volume Down
0x43	Mute
0x44	Play
0x45	Stop
0x46	Pause
0x47	Record
0x48	Rewind
0x49	Fast forward
0x4A	Eject
0x4B	Forward
0x4C	Backward
0x4D	Stop-Record
0x4E	Pause-Record
0x4F	Reserved
0x50	Angle
0x51	Sub picture
0x52	Video on Demand
0x53	Electronic Program Guide
0x54	Timer Programming

Operation id	User Operation
0x55	Initial Configuration
0x56 - 0x5F	Reserved
0x60	Play Function
0x61	Pause-Play Function
0x62	Record Function
0x63	Pause-Record Function
0x64	Stop Function
0x65	Mute Function
0x66	Restore Volume Function
0x67	Tune Function
0x68	Select Media Function
0x69	Select A/V Input Function
0x6A	Select Audio Input Function
0x6B	Power Toggle Function
0x6C	Power Off Function
0x6D	Power On Function
0x6E – 0x70	Reserved
0x71	F1 (Blue)
0x72	F2 (Red)
0x73	F3 (Green)
0x74	F4 (Yellow)
0x75	F5
0x76	Data – see Note 3
0x77 – 0xFF	Reserved

Note 1: The elements identified in **bold** are the only ones which are forwarded as part of the device menu control feature.

Note 2: This is the initial display that a device shows. It is device-dependent and can be, for example, a contents menu, setup menu, favorite menu or other menu. The actual menu displayed may also depend on the device’s current state.

Note 3: This is used, for example, to enter or leave a digital TV data broadcast application.

CEC Table 28 Broadcast System

System	Value	Bits 43210	Sound Carrier	Sound Modulation	Video Modulation	Vertical Frequency	Color sub- carrier
PAL B/G	0	00000	5.5 MHz	FM	neg	50 Hz	4.43 MHz
SECAM L'	1	00001	6.5 MHz	AM	Pos	50 Hz	³⁰
PAL M	2	00010	4.5 MHz	FM	neg	60 Hz	3.5756MHz
NTSC M	3	00011	4.5 MHz	FM	neg	60 Hz	3.5795MHz
PAL I	4	00100	6.0 MHz	FM	neg	50 Hz	4.43 MHz
SECAM DK	5	00101	6.5 MHz	FM	neg	50 Hz	³⁰
SECAM B/G	6	00110	5.5 MHz	FM	neg	50 Hz	³⁰
SECAM L	7	00111	6.5 MHz	AM	pos	50 Hz	³⁰
PAL DK	8	01000	6.5 MHz	FM	neg	50 Hz	4.43 MHz
Future use	9	01001					
..					
Future use	30	11110					
Other System ³¹	31	11111					

³⁰ Color sub-carriers SECAM: f_{OB} 4.25 MHz, f_{OR} 4.406 MHz

³¹ The system is not defined. The receiving device decides locally what to do.

CEC Appendix A Non-CEC Switch (Informative)

There are two types of non-CEC Switches, those which have only one EDID for all source devices (or simply reflect the sink EDID), and those which have a separate EDID for all source devices. The rules for the operation of these two types of Switch are different:

Note that the use of non-CEC Switches is deprecated, see CEC 11.

CEC A1 Switches with One EDID

A non-CEC-compliant Switch may have a single child_address, which is always occupied by the currently switched device. Any other connected devices will have no hot plug signal and will therefore have an unallocated physical address (and can use only the unregistered logical address). These devices will, however, still see CEC messages as they will be connected to the CEC line and they may react to some broadcast messages in the normal way (e.g. standby).

When a Switch de-selects a device, that device will detect the removal of the 'hot plug' signal to indicate that its physical AV connection has been removed. It should immediately clear its physical and logical addresses. Each source device below the Switch will detect the removal of the 'hot plug' signal to indicate they are no longer on the active AV Path and clear their addresses accordingly.

When a Switch selects a device, that device will detect the 'hot plug' signal. It can then obtain a valid physical address from its sink and subsequently a logical address. The device should activate the hot plug signal to its source (child) devices (if any) to indicate that they should now request a physical address.

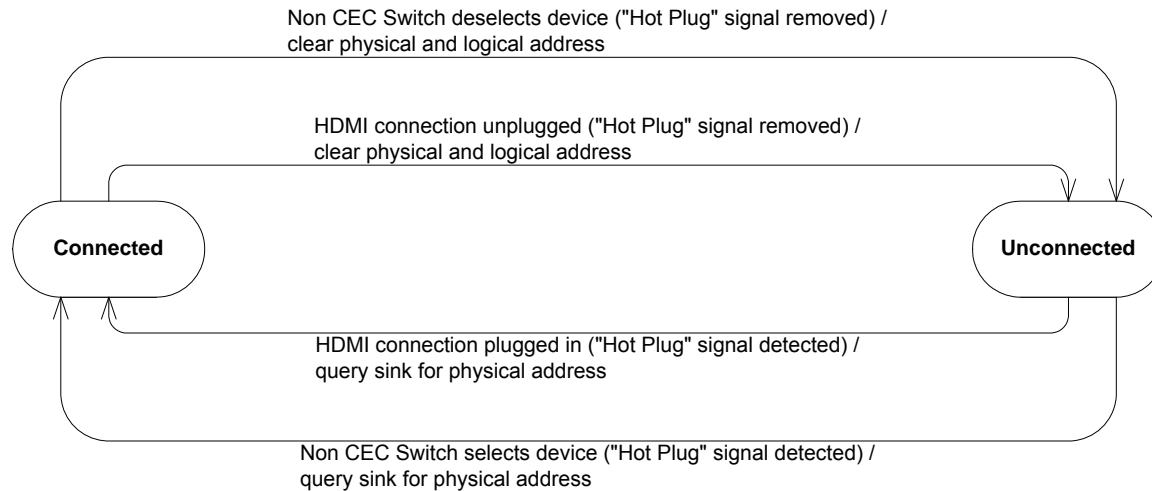

CEC Figure A1 A device's behavior when it is beneath a 1 EDID non-CEC Switch.

CEC A2 Switches with Multiple EDIDs

These should operate as CEC Switches except that they do not send messages on, or monitor, the CEC line.